

1-Phase PV Grid-Connected Inverter

User Manual

**SG2.0RS-S / SG2.5RS-S / SG3.0RS-S /
SG3.0RS / SG3.6RS / SG4.0RS /
SG5.0RS / SG6.0RS**



All Rights Reserved

All Rights Reserved

No part of this document can be reproduced in any form or by any means without the prior written permission of Sungrow Power Supply Co., Ltd (hereinafter "SUNGROW").

Trademarks

SUNGROW and other Sungrow trademarks used in this manual are owned by SUNGROW.

All other trademarks or registered trademarks mentioned in this manual are owned by their respective owners.

Software Licenses

- It is prohibited to use data contained in firmware or software developed by SUNGROW, in part or in full, for commercial purposes by any means.
- It is prohibited to perform reverse engineering, cracking, or any other operations that compromise the original program design of the software developed by SUNGROW.

About This Manual

The manual mainly contains the product information, as well as guidelines for installation, operation and maintenance. The manual does not include complete information about the photovoltaic (PV) system. The reader can get additional information about other devices at www.sungrowpower.com or on the webpage of the respective component manufacturer.

Validity

This manual is valid for the following inverter models:

- SG2.0RS-S
- SG2.5RS-S
- SG3.0RS-S
- SG3.0RS
- SG3.6RS
- SG4.0RS
- SG5.0RS
- SG6.0RS

They will be referred to as "inverter" hereinafter unless otherwise specified.

Target Group

This manual is intended for inverter owners who will have the ability to interact with the inverter and qualified personnel who are responsible for the installation and commissioning of the inverter. Qualified personnel should have the following skills:

- Training for installation and commissioning of electrical system, as well as dealing with hazards
- Knowledge of the manual and other related documents
- Knowledge of the local regulations and directives

How to Use This Manual

Read the manual and other related documents before performing any work on the inverter. Documents must be stored carefully and be available at all times.

Contents may be periodically updated or revised due to the product development. The manual content of subsequent versions of the inverter may be subject to change. The latest manual can be found at support.sungrowpower.com.

Symbols

Important instructions contained in this manual should be followed during installation, operation and maintenance of the inverter. They will be highlighted by the following symbols.

 **DANGER**

Indicates a hazard with a high level of risk that, if not avoided, will result in death or serious injury.

 **WARNING**

Indicates a hazard with a medium level of risk that, if not avoided, could result in death or serious injury.

 **CAUTION**

Indicates a hazard with a low level of risk that, if not avoided, could result in minor or moderate injury.

NOTICE

Indicates a situation that, if not avoided, could result in equipment or property damage.



Indicates additional information, emphasized contents or tips that may be helpful, e.g. to help you solve problems or save time.

Contents

All Rights Reserved	I
About This Manual	II
1 Safety	1
1.1 PV Panels	1
1.2 Utility Grid	1
1.3 Inverter	2
2 Product Description	4
2.1 System Introduction	4
2.2 Product Introduction	5
2.3 Symbols on the Product	7
2.4 LED Panel	8
2.5 Circuit Diagram	9
2.6 Function Description	10
3 Unpacking and Storage	12
3.1 Unpacking and Inspection	12
3.2 Inverter Storage	12
4 Mechanical Mounting	13
4.1 Safety during Mounting	13
4.2 Location Requirements	13
4.2.1 Environment Requirements	14
4.2.2 Carrier Requirements	14
4.2.3 Angle Requirements	14
4.2.4 Clearance Requirements	15
4.3 Installation Tools	15
4.4 Moving the Inverter	17
4.5 Installing the Inverter	17
5 Electrical Connection	19
5.1 Safety Instructions	19
5.2 Terminal Description	19
5.3 Electrical Connection Overview	21
5.4 Additional Grounding Connection	22

5.4.1 Additional Grounding Requirements.....	22
5.4.2 Connection Procedure.....	22
5.5 AC Cable Connection.....	23
5.5.1 AC Side Requirements.....	23
5.5.2 Assembling the AC Connector.....	24
5.5.3 Installing the AC Connector.....	26
5.6 DC Cable Connection.....	27
5.6.1 PV Input Configuration.....	27
5.6.2 Assembling the PV Connectors.....	28
5.6.3 Installing the PV Connectors.....	29
5.7 WiNet-S Connection.....	31
5.7.1 Ethernet Communication.....	31
5.7.2 WLAN Communication.....	33
5.8 Meter Connection.....	33
5.9 DRM Connection.....	35
6 Commissioning.....	39
6.1 Inspection before Commissioning.....	39
6.2 Powering on the System.....	39
6.3 App Preparation.....	39
6.4 Creating a Plant.....	40
6.5 Initializing the Device.....	43
6.6 Configuring the Plant.....	45
7 iSolarCloud App.....	50
7.1 Brief Introduction.....	50
7.2 Installing the App.....	50
7.3 Account Registration.....	51
7.4 Login.....	52
7.4.1 Requirements.....	52
7.4.2 Login Procedure.....	52
7.5 Initial Settings.....	54
7.6 Function Overview.....	55
7.7 Home.....	56
7.8 Run Information.....	57
7.9 Records.....	58
7.10 More.....	61
7.10.1 System Parameters.....	61

7.10.2 Operation Parameters	62
7.10.3 Power Regulation Parameters.....	63
7.10.4 Communication Parameters	67
7.10.5 Firmware Update.....	67
8 System Decommissioning	69
8.1 Disconnecting the Inverter.....	69
8.2 Dismantling the Inverter.....	69
8.3 Disposal of the Inverter.....	70
9 Troubleshooting and Maintenance	71
9.1 Troubleshooting	71
9.2 Maintenance.....	74
9.2.1 Maintenance Notices.....	74
9.2.2 Routine Maintenance.....	76
10 Appendix	77
10.1 Technical Data	77
10.2 Quality Assurance	82
10.3 Contact Information	83

1 Safety

The device has been designed and tested strictly according to international safety regulations. Read all safety instructions carefully prior to any work and observe them at all times when working on or with the device.

Incorrect operation or work may cause:

- Injury or death to the operator or a third party;
- Damage to the device and other properties.

All detailed work-related safety warnings and notes are specified at critical points in this manual.



The safety instructions in this manual cannot cover all the precautions that should be followed. Perform operations considering actual onsite conditions. SUNGROW shall not be held liable for any damage caused by violation of the safety instructions in this manual.

1.1 PV Panels

DANGER

PV strings will produce electrical power when exposed to sunlight and can cause a lethal voltage and an electric shock.

- Always keep in mind that the inverter is dual power supplied. Electrical operators must wear proper personal protective equipment: helmet, insulated footwear, gloves, etc.
- Before touching the DC cables, operator must use a measuring device to ensure that the cable is voltage-free.
- The operator must follow all warnings on the PV strings and in its manual.

1.2 Utility Grid

Follow the regulations related to the utility grid.

NOTICE

All electrical connections must be in accordance with local and national standards.

Only with the permission of the local utility grid company, the inverter can be connected to the utility grid.

1.3 Inverter

⚠ DANGER

Danger to life from electric shocks due to live voltage

Do not open the enclosure at any time. Unauthorized opening will void warranty and warranty claims and in most cases terminate the operating license.

⚠ WARNING

Risk of inverter damage or personal injury

- Do not connect or disconnect the PV and AC connectors when the inverter is running.
- Wait at least 10 minutes for the internal capacitors to discharge after all electric devices are removed and the inverter is powered off.
- Ensure that there is no voltage or current before connecting or disconnecting the PV and AC connectors.

⚠ WARNING

All safety instructions, warning labels, and nameplate on the inverter:

- Must be clearly legible.
- Should not be removed or covered.

⚠ CAUTION

Risk of burns due to hot components!

Do not touch any hot parts (such as the heat sink) during operation. Only the DC switch and the LED panel can safely be touched at any time.

NOTICE

Only qualified personnel can perform the country setting. Unauthorized alteration may cause a breach of the type-certificate marking.

Risk of inverter damage due to electrostatic discharge (ESD)!

By touching the electronic components, you may damage the inverter. For inverter handling, be sure to:

- avoid any unnecessary touching;
- wear a grounding wristband before touching any connectors.

2 Product Description

2.1 System Introduction

The inverter is a transformerless 1-phase PV grid-connected inverter. As an integral component in the PV power system, the inverter is designed to convert the direct current power generated from the PV modules into grid-compatible AC current and feeds the AC current to the utility grid.

⚠ WARNING

- The inverter must only be operated with PV strings with class II protection in accordance with IEC 61730, application class A. It is not allowed for the positive pole or the negative pole of the PV strings to be grounded. This can cause damage to the inverter.
- Damages to the product due to a faulty or damaged PV installation are not covered by warranty.
- Any use other than the one described in this document is not permitted.

The intended usage of the inverter is illustrated in the following figure.

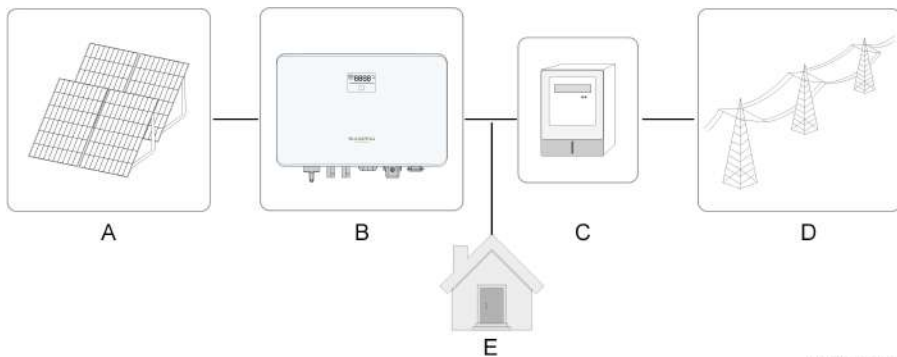
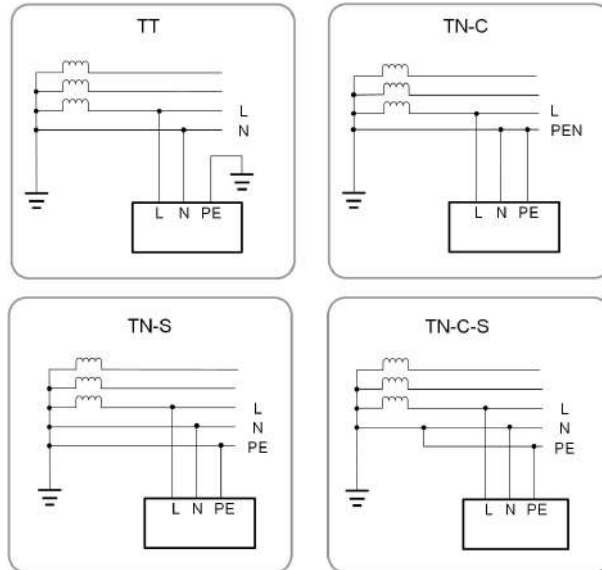

figure 2-1 Inverter Application in PV Power System

Item	Description	Note
A	PV strings	Compatible with monocrystalline silicon, polycrystalline silicon, and thin-film modules without grounding.
B	Inverter	SG2.0RS-S, SG2.5RS-S, SG3.0RS-S, SG3.0RS, SG3.6RS, SG4.0RS, SG5.0RS, SG6.0RS.
C	Metering device	Meter cupboard with power distribution system.

Item	Description	Note
D	Utility grid	TT, TN-C, TN-S, TN-C-S.
E	Loads	House loads that consume electricity.

The following figure shows the common grid configurations.



S005-G002

2.2 Product Introduction

Model Description

The model description is as follows (take SG3.0RS-S as an example):

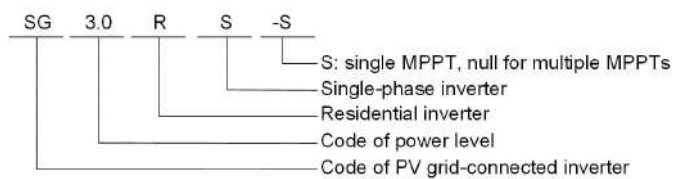

S005-G003

Appearance

The following figure shows the dimensions of the inverter. The image shown here is for reference only. The actual product received may differ.

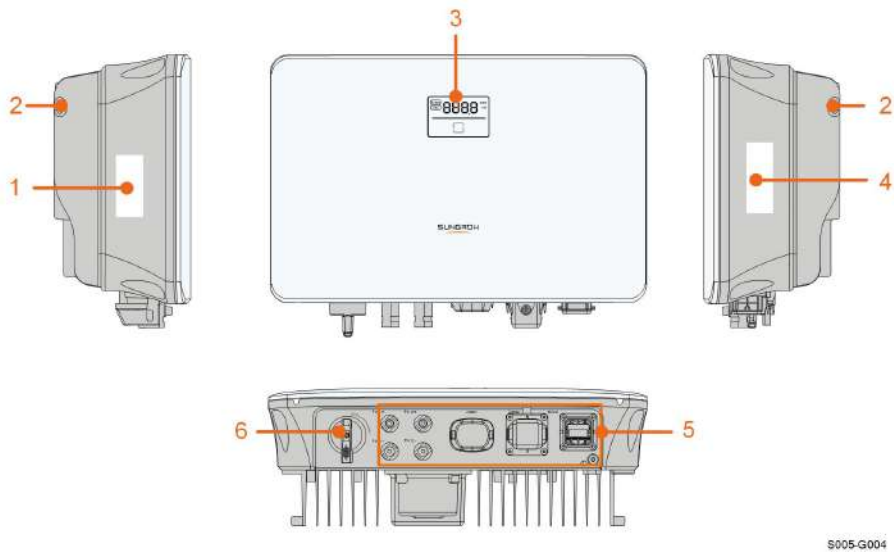

figure 2-2 Inverter Appearance

No.	Name	Description
1	Label	Information about COM2 pin definition, supported DRM modes, etc.
2	Hanger	Complement to the included wall mounting bracket for hanging the inverter.
3	LED pannel	The LED screen indicates the running information and the LED indicator indicates the working state of the inverter.
4	Nameplate	To clearly identify the product, including device model, S/ N, important specifications, marks of certification institutions, etc.
5	Electrical connection area	DC terminals (SG6.0RS for example), AC terminal, additional grounding terminal and communication terminals.
6	DC switch	To safely disconnect the DC circuit whenever necessary.

Dimensions

The following figure shows the dimensions of the inverter.

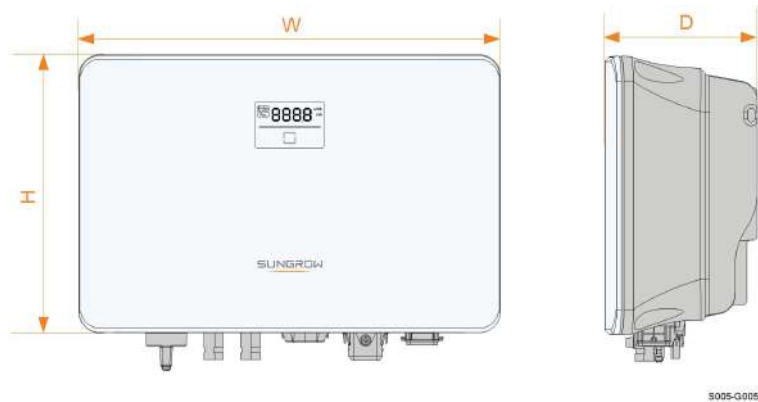















figure 2-3 Dimensions of the Inverter

Inverter Model	W (mm)	H (mm)	D (mm)
SG2.0RS-S, SG2.5RS-S, SG3.0RS-S	320	225	120
SG3.0RS, SG3.6RS, SG4.0RS, SG5.0RS, SG6.0RS	410	270	150

2.3 Symbols on the Product

Symbol	Explanation
	Parameters on the DC side.
 AC-Grid	Parameters on the AC on-grid side.
	Regulatory compliance mark.
	TÜV mark of conformity.
	CE mark of conformity.
	Do not dispose of the inverter together with household waste.
	The inverter does not have a transformer.
	Disconnect the inverter from all the external power sources before maintenance!
	Read the user manual before maintenance!

Symbol	Explanation
	Burn danger due to the hot surface that may exceed 60°C.
 	Danger to life due to high voltages! Do not touch live parts for 10 minutes after disconnection from the power sources. Only qualified personnel can open and maintain the inverter.
	Additional grounding point.

* The table shown here is for reference only. The actual product received may differ.

2.4 LED Panel

The LED panel with a display screen and an indicator is on the front of the inverter.

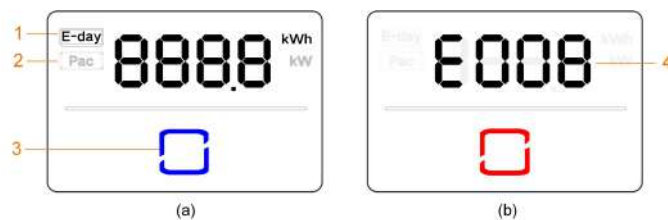

figure 2-4 LED Panel



(a) Normal state

(b) Error state

No.	Name	Description
1	E-day	Today ' s energy yield.
2	Pac	Current AC power.
3	LED indicator	To indicate the working state of the inverter. Touch it to switch the information in normal state or view multiple error codes in error state.
4	Error code	The error code in the figure is just an example.

- In normal state, the E-day and Pac information will be displayed alternately. Also you can touch the LED indicator to switch the information.
- In error state, touch the LED indicator to view multiple error codes.
- If there is no operation for 5 minutes, the display screen will be off. Touch the LED indicator to activate it.

table 2-1 State description of the LED indicator

LED color	State	Definition
 Blue	On Flashing	The inverter is operating normally. The inverter is at standby or startup state (not feeding power into the grid).
 Red	On	A system fault has occurred.
 Gray	Off	Both the AC and DC sides are powered down.

2.5 Circuit Diagram

The following figure shows the main circuit of the inverter.

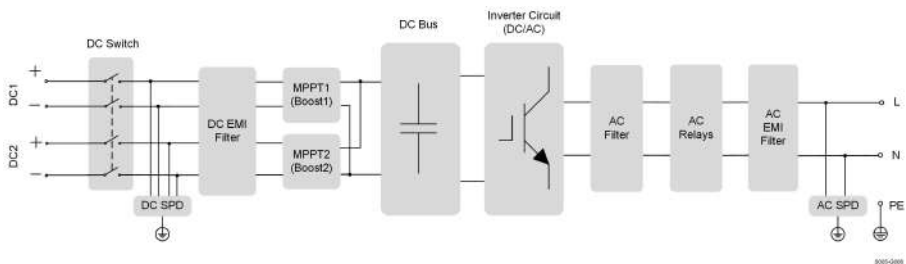

figure 2-5 Circuit Diagram (SG6.0RS for example)

- The DC switch is used to safely disconnect the DC circuit.
- The MPPT is utilized for DC input to ensure the maximum power from the PV array at different PV input conditions.
- The inverter circuit converts the DC power into AC power and generates AC power to loads or utility grid through the AC terminal.
- The protection circuit ensures the safe operation of the device and personal safety.

2.6 Function Description

Basic Function

- Conversion function

The inverter converts the DC power from the PV array to the AC power, in conformity with the grid requirements.

- Data storage

The inverter logs running information, error records, etc.

- Parameter configuration

The inverter provides various parameter configurations for optimal operation. Parameters can be set via the iSolarCloud App or the cloud server. For further configurations, which exceeds the usual parameters configuration, please contact Sungrow.

- Communication interface

The inverter is equipped with two communication interfaces. The communication device can be connected to the inverter via both interfaces.

After communication connection is established, users can view inverter information, operational data and can set inverter parameters through the iSolarCloud.



It is recommended to use the communication module from SUNGROW. Using a device from other companies may lead to communication failure or other unexpected damage.

- Protection Function

Several protective functions are integrated in the inverter, including short circuit protection, grounding insulation resistance monitoring, residual current protection, grid monitoring, DC overvoltage/overcurrent protection, etc.

DRM ("AU"/"NZ")

The DRM function is only applicable to a single inverter.

The inverter provides terminals for connecting to a Demand Response Enabling Device (DRED). After the connection, the DRED asserts demand response modes (DRMs). The inverter detects and initiates a response to all supported demand response modes listed in the following table.

table 2-2 Demand Response Mode Explanation

Mode	Explanation
DRM0	The inverter is in the state of standby.

Feed-in Limitation

Set the feed-in limitation value via iSolarCloud App. When the smart energy meter detects that the export power is greater than the limit value, the inverter will reduce the output power within the specified range.

PID Recovery

The inverter is equipped with PID phenomenon recovery function to improve the PV power generation. During the power generation process, the inverter could carry out a main Anti-PID function without any influence to the grid side thanks to a particular technology.

The PID recovery function is disabled by default. Enable the function via iSolarCloud App when there is PV power in the daytime. During the inverter standby process with no irradiance, an additional PID recovery function could apply inverse voltage to PV modules, to restore the degraded modules.

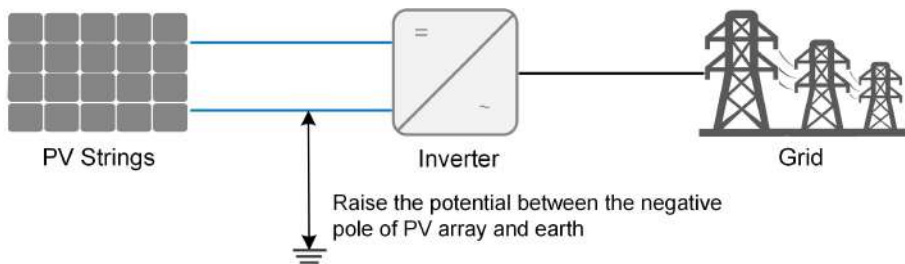

figure 2-6 PID Recovery Scheme

⚠ DANGER

Keep the DC switch "ON" in the PID recovery process. During the process, there is voltage hazard between inverter/PV module live conductors and ground. Do not touch any of them.

AFCI Function(Optional)

- AFCI activation

This function can be enabled to detect whether arc occurs in the DC cable of the inverter.

- AFCI self-test

This function is intended to detect whether the AFCI function of the inverter is normal.

3 Unpacking and Storage

3.1 Unpacking and Inspection

The device is thoroughly tested and strictly inspected before delivery. Nonetheless, damage may still occur during shipping. For this reason, please conduct a thorough inspection after receiving the device.

- Check the packing case for any visible damage.
- Check the scope of delivery for completeness according to the packing list.
- Check the inner contents for damage after unpacking.

Contact SUNGROW or the transport company in case of any damage or incompleteness, and provide photos to facilitate services.

Do not dispose of the original packing case. It is recommended to store the device in the original packing case when the device is decommissioned.

3.2 Inverter Storage

Proper storage is required if the inverter is not installed immediately.

- Store the inverter in the original packing case with the desiccant inside.
- The storage temperature must be always between -30°C and $+70^{\circ}\text{C}$, and the storage relative humidity must be always between 0 and 95 %, non-condensing.
- In case of stacking storage, the number of stacking layers should never exceed the limit marked on the outer side of the packing case.
- The packing case should be upright.
- If the inverter has been stored more than half a year, the qualified personnel should thoroughly check and test it before installation.

4 Mechanical Mounting

⚠ WARNING

Respect all local standards and requirements during mechanical installation.

4.1 Safety during Mounting

⚠ DANGER

Make sure there is no electrical connection before installation.
In order to avoid electric shock or other injury, make sure that holes will not be drilled over any electricity or plumbing installations.

⚠ CAUTION

Risk of injury due to improper handling

- Always follow the instructions when moving and positioning the inverter.
- Improper operation may cause injuries or serious wounds.

In the case of poor ventilation, the system performance may compromise.

- Keep the heat sinks uncovered to ensure heat dissipation performance.

4.2 Location Requirements

Select an optimal mounting location for safe operation, long service life and expected performance.

- The inverter with protection rating IP65 can be installed both indoors and outdoors.
- Install the inverter at a place convenient for electrical connection, operation, and maintenance.

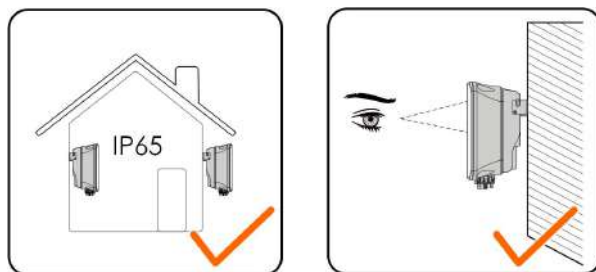

S005-I001

4.2.1 Environment Requirements

- The installation environment must be free of inflammable or explosive materials.
- The location should be not accessible to children.
- The ambient temperature and relative humidity must meet the following requirements.

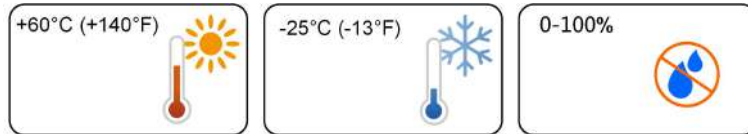

- Avoid direct exposure to sun, rain and snow.
- The inverter should be well ventilated. Ensure air circulation.

4.2.2 Carrier Requirements

The concrete wall should be capable of withstanding a force of four times the weight of the inverter and be suitable for the dimensions of the inverter.

The installation carrier should meet the following requirements:

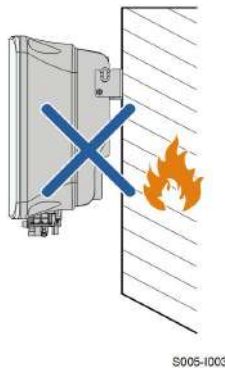

4.2.3 Angle Requirements

Install the inverter vertically. Never install the inverter horizontally, or at forward/backward tilted, side tilted, or upside down.

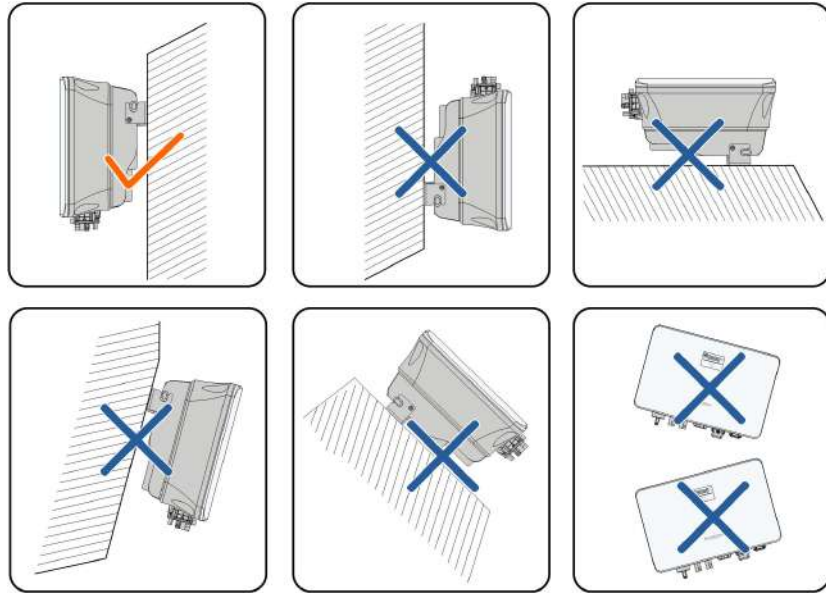

S005-I004

4.2.4 Clearance Requirements

Reserve enough clearance around the inverter to ensure sufficient space for heat dissipation.

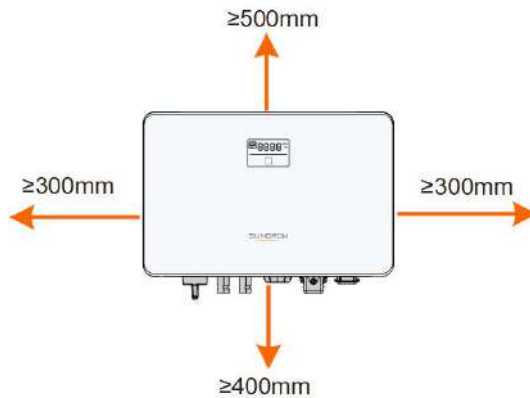

S005-I005

Install the inverter at an appropriate height for ease of viewing the screen and LED indicator and operating switch(es).

4.3 Installation Tools

Installation tools include but are not limited to the following recommended ones. If necessary, use other auxiliary tools on site.

table 4-1 Tool specification

			
Goggles	Earplugs	Dust mask	Protective gloves
			
Insulated shoes	Utility knife	Marker	Wrist strap
			
Wire cutter	Wire stripper	Hydraulic plier	RJ45 crimping tool
			
MC4 terminal crimping tool (4 mm ² – 6 mm ²)	Tube terminal crimping tool (0.5 mm ² – 1.0 mm ²)	Electric screwdriver (M4, M6)	Slotted screwdriver (M2)
			
Phillips screwdriver (M4)	Vacuum cleaner	Measuring tape	Heat shrink tubing
			

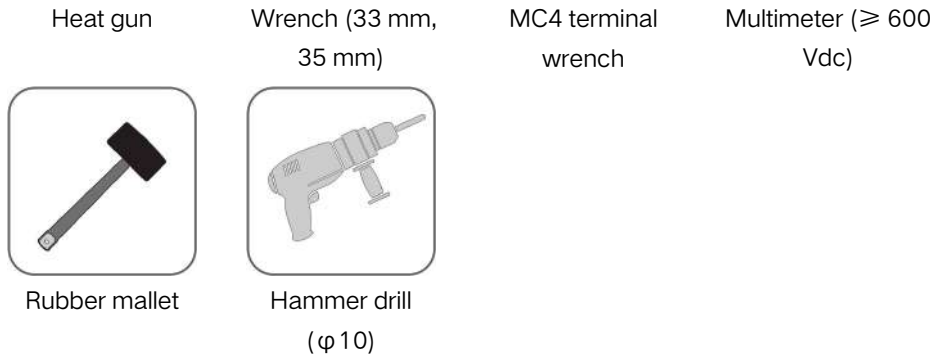

4.4 Moving the Inverter

Before installation, remove the inverter from the packing case and move it to the installation site. Follow the instructions below as you move the inverter:

- Always be aware of the weight of the inverter.
- Lift the inverter using the handles positioned on both sides of the inverter.
- Move the inverter by one or two people or by using a proper transport tool.
- Do not release the equipment unless it has been firmly secured.

4.5 Installing the Inverter

Inverter is installed on the wall by means of wall-mounting bracket and the expansion plug sets.

The expansion plug set shown below is recommended for the installation.



(1) Self-tapping screw M6 (2) Expansion tube (3) Fender washer (4) Spring washer

step 1 Place the wall-mounting bracket to a proper position on the wall. Mark the positions and drill the holes.

NOTICE

Observe the level on the bracket and adjust until the bubble is in the middle position.

The depth of the holes should be about 70 mm.

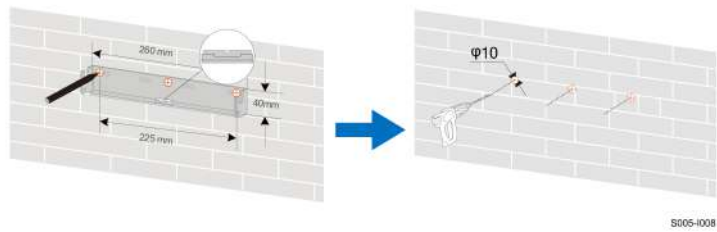

step 2 Place the expansion tubes into the holes. Then secure the wall-mounting bracket to the wall firmly with the expansion bolt sets.

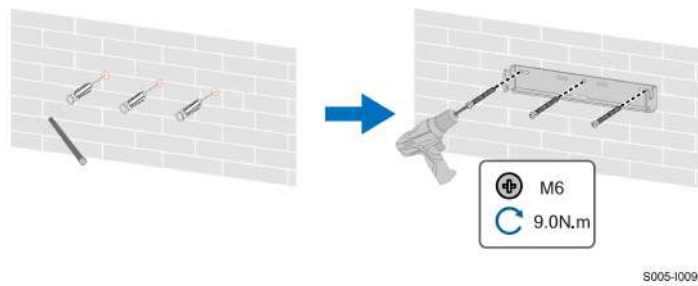

step 3 Lift the inverter and slide it down along the wall-mounting bracket to make sure they match perfectly. Use two screw sets to lock both left and right sides.

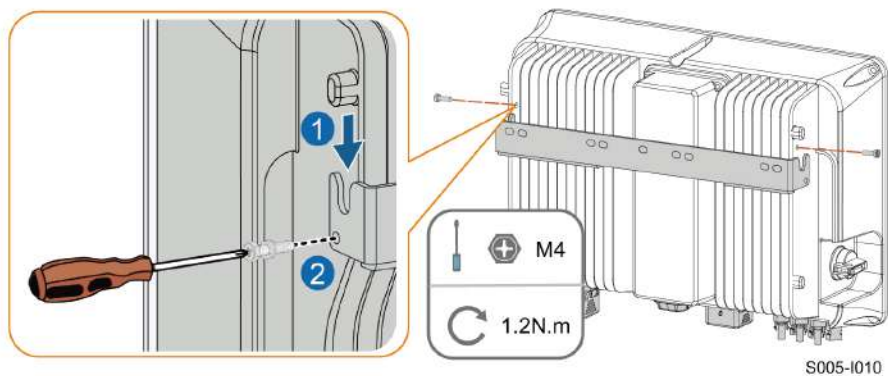

-- End

5 Electrical Connection

5.1 Safety Instructions

Prior to any electrical connections, keep in mind that the inverter has dual power supplies. It is mandatory for the qualified personnel to wear personal protective equipments (PPE) during the electrical work.

DANGER

Danger to life due to a high voltage inside the inverter!

- The PV string will generate lethal high voltage when exposed to sunlight.
- Before starting electrical connections, disconnect the DC and AC circuit breakers and prevent them from inadvertent reconnection.
- Ensure that all cables are voltage free before performing cable connection.

WARNING

- Any improper operations during cable connection can cause device damage or personal injury.
- Only qualified personnel can perform cable connection.
- All cables must be undamaged, firmly attached, properly insulated and adequately dimensioned.

NOTICE

Comply with the safety instructions related to the PV strings and the regulations related to the utility grid.

- All electrical connections must be in accordance with local and national standards.
- Only with the permission of the local utility grid company, the inverter can be connected to the utility grid.

5.2 Terminal Description

All electrical terminals are located at the bottom side of the inverter.

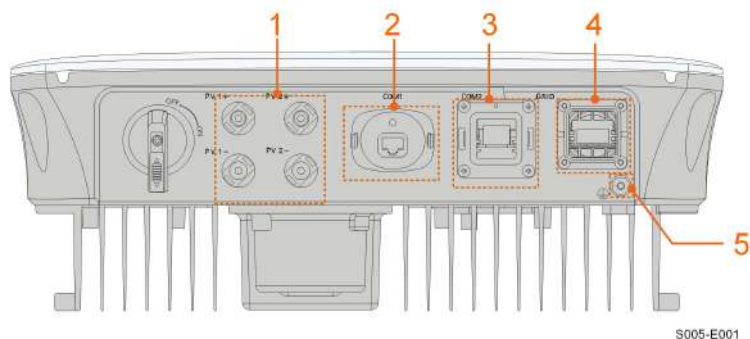



figure 5-1 Terminals (SG3.0RS for example)

* The image shown here is for reference only. The actual product received may differ.

table 5-1 Terminal Description

No.	Name	Description	Decisive Voltage Classification
1	PV1+, PV1 -, PV2+, PV2 -	MC4 terminals for PV input. The terminal number depends on inverter model.	DVC-C
2	COM1	Communication accessory port to be connected to WiNet-S communication module.	DVC-A
3	COM2	Communication connection for RS485, DRM and smart energy meter.	DVC-A
4	GRID	AC terminal to connect to the grid.	DVC-C
5		Additional grounding terminal.	Not applicable

The pin definition of COM2 terminal is shown in the following label.

RS485	Meter	DRM	RSD
A1	A2	R	RSD-1
B1	B2	C	RSD-2

figure 5-2 Label of COM2 Terminal

table 5-2 Label Description of COM2 Terminal

Label	Description
RS485	A1, B1 Reserved
Meter	A2, B2 For the smart energy meter

Label	Description	
DRM	R, C	For external Demand Response Enabling Device ("AU"/"NZ")
RSD	RSD-1, RSD-2	Reserved

5.3 Electrical Connection Overview

The electrical connection should be realized as follows:

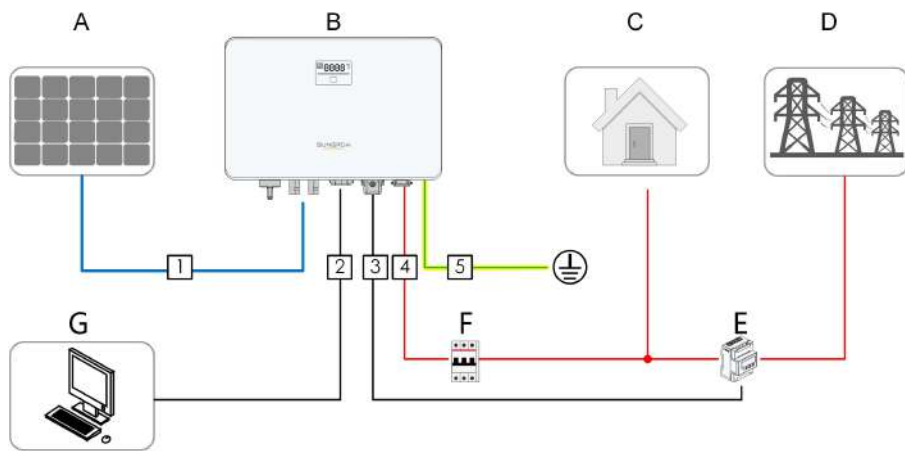

S005-E005

- (A) PV string (B) Inverter (C) Loads
 (D) Grid (E) Smart energy meter (optional)
 (F) AC circuit breaker (G) External device

table 5-3 Cable Requirements

No.	Cable	Type	Cable Diameter	Wire Conductor Cross-section
1	DC cable	Single or multi-core copper wire complying with 600 V and 20 A standard	6 mm – 9 mm	4 mm ² – 6 mm ²
2	Ethernet cable	CAT 5E outdoor shielded network cable	4.8 mm – 6 mm	8 * (0.08 – 0.2) mm ²
3	Meter RS485 cable ⁽¹⁾	Shielded twisted pair	4.8 mm – 6 mm	2 * (0.5 – 1.0) mm ²

No.	Cable	Type	Cable Diameter	Wire Conductor Cross-section
4	AC cable (2)	Outdoor 3-core copper wire cable	12 mm – 25 mm	4 mm ² – 6 mm ²
5	Additional Grounding cable	Outdoor single-core copper wire cable	The same as that of the PE wire in the AC cable	

(1) The cable requirements for **COM2** terminal connection are the same.

(2) All the AC wires should be equipped with correctly colored cables for distinguishing. Please refer to related standards about the wiring color.

5.4 Additional Grounding Connection

WARNING

- Since the inverter is transformerless, neither the negative pole nor the positive pole of the PV string must be grounded. Otherwise, the inverter will not operate normally.
- Connect the additional grounding terminal to the protective grounding point before AC cable connection, PV cable connection, and communication cable connection.
- The ground connection of this additional grounding terminal cannot replace the connection of the PE terminal of the AC cable. Make sure those terminals are both grounded reliably. SUNGROW shall not be held liable for any damage caused by the violation.

5.4.1 Additional Grounding Requirements

All non-current carrying metal parts and device enclosures in the PV power system should be grounded, for example, mounts of PV modules and the inverter enclosure.

When there is only one inverter in the PV system, connect the additional grounding cable to a nearby grounding point.

When there are multiple inverters in the PV system, connect grounding points of all inverters and the PV array frames to the equipotential cable (according to the onsite conditions) to implement an equipotential connection.

5.4.2 Connection Procedure

Additional grounding cable and OT/DT terminal are prepared by customers.

step 1 Prepare the cable and OT/DT terminal.

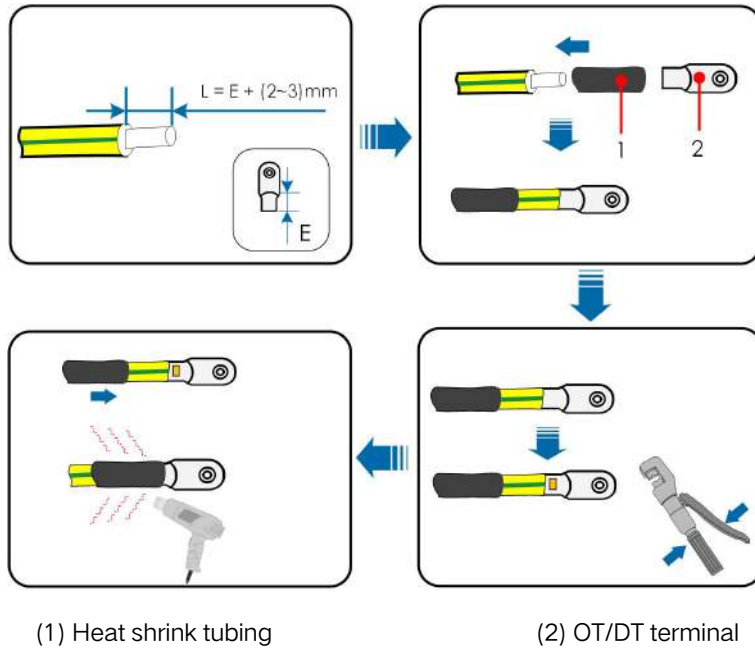

step 2 Remove the screw on the grounding terminal and fasten the cable with a screwdriver.

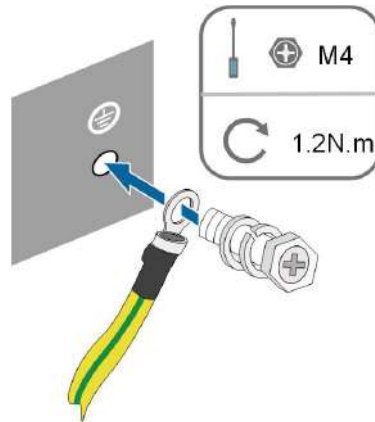

step 3 Apply paint to the grounding terminal to ensure corrosion resistance.

-- End

5.5 AC Cable Connection

5.5.1 AC Side Requirements



Connect the inverter to the grid only after getting an approval from the local electric power company.

Before connecting the inverter to the grid, ensure the grid voltage and frequency comply with requirements, for which, refer to "**Technical Data**". Otherwise, contact the electric power company for help.

AC Circuit Breaker

An independent two-pole circuit breaker must be installed on the output side of the inverter to ensure safe disconnection from the grid. The recommended specifications are as follows.

Inverter Model	Recommended Specification
SG2.0RS-S/SG2.5RS-S/SG3.0RS-S	25 A
SG3.0RS/SG3.6RS/SG4.0RS/SG5.0RS	32 A
SG6.0RS	40 A

NOTICE

- Determine whether an AC circuit breaker with greater overcurrent capacity is required based on actual conditions.
- Multiple inverters cannot share one circuit breaker.
- Never connect a load between the inverter and the circuit breaker.

Residual Current Monitoring Device

With an integrated universal current-sensitive residual current monitoring unit included, the inverter will disconnect immediately from the mains power once a fault current with a value exceeding the limit is detected.

However if an external residual current device (RCD) is mandatory, the switch must be triggered at a residual current of 300 mA (recommended), or it can be set to other values according to local regulations. For example in Australia, the inverter can use an additional 30 mA (type A) RCD in installations.

5.5.2 Assembling the AC Connector

step 1 Unscrew the swivel nut of the AC connector.

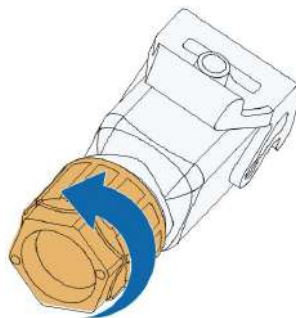

S000-E047

step 2 Thread the AC cable of appropriate length through the swivel nut, the sealing ring and the housing.

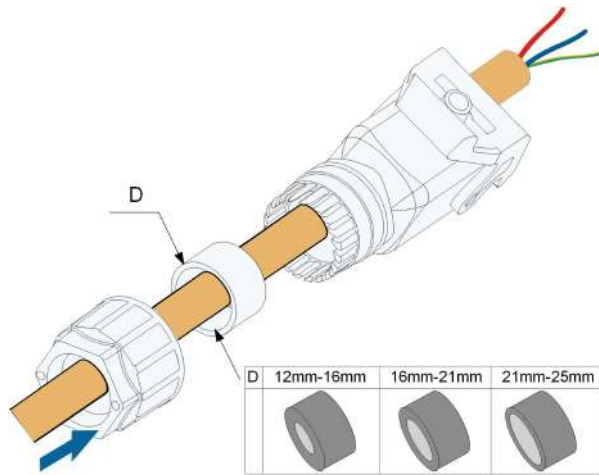

S000-E049

step 3 Remove the cable jacket by less than 45 mm, and strip the wire insulation by 12 mm – 16 mm.

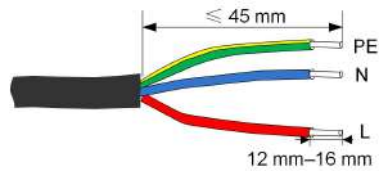

S000-E050

step 4 Open the clamp on the spring-loaded terminal and fully insert the wires into the corresponding holes. Then close the clamp and push the terminal plug into the housing until there is an audible click.

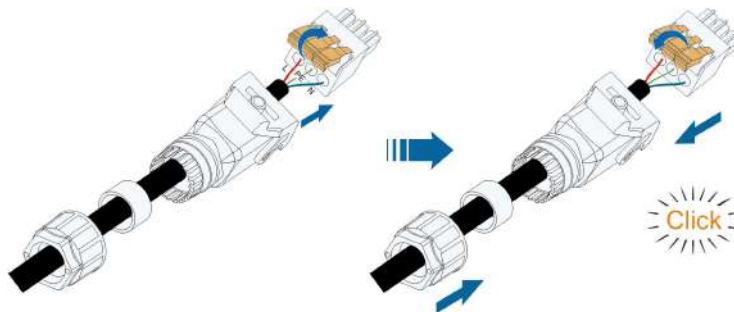

S000-E051

NOTICE

Observe the plug assignment.

- Do not connect the L line to the "PE" terminal or the PE wire to the "N" terminal. Otherwise, unrecoverable damage to the inverter may follow.
- Do not connect the L line and the N line in reverse, otherwise the inverter may not operate normally.

step 5 Ensure that the wires are securely in place by slightly pulling them. Tighten the swivel nut to the housing.

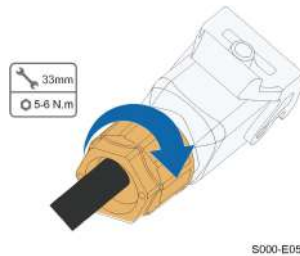

-- End

5.5.3 Installing the AC Connector

⚠ DANGER

High voltage may be present in inverter!

Ensure all cables are voltage-free before electrical connection.

Do not connect the AC circuit breaker until all inverter electrical connections are completed.

step 1 Disconnect the AC circuit breaker and secure it against reconnection.

step 2 Lift the locking part upwards and insert the AC connector into the **GRID** terminal on the bottom side of the inverter. Then press the locking part and lock it with the screw.

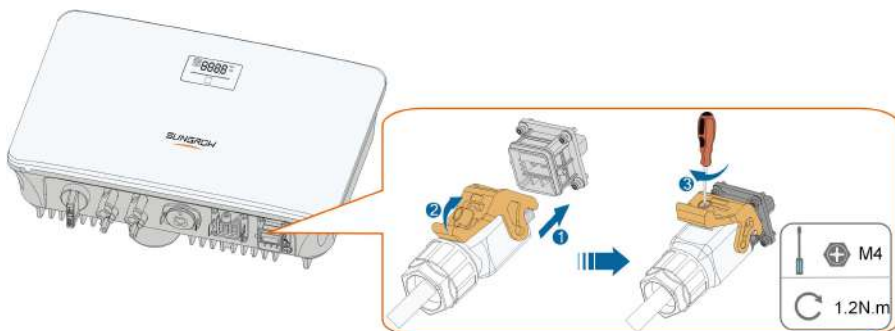

step 3 Connect the PE wire to ground and the phase lines and the “N” line to AC circuit breaker. Then Connect the AC circuit breaker to electric board.

step 4 Make sure all wires are firmly installed via the right torque tool or dragging the cables slightly.

-- End

5.6 DC Cable Connection

DANGER

Danger of electric shock!

The PV array will generate lethal high voltage once exposed to sunlight.

WARNING

Make sure the PV array is well insulated to ground before connecting it to the inverter.

NOTICE

Risk of inverter damage! Observe the following requirements. Failure to do so will void guarantee and warranty claims.

- Make sure the maximum DC voltage and the maximum short circuit current of any string never exceed inverter permitted values specified in "Technical Data".
- Mixed use of different brand or model of PV modules in a PV string or a compromised PV string design composed with PV modules from rooftops of different orientation may not damage inverter but will cause system bad performance!
- The inverter enters standby state when the input voltage ranges between 560 V and 600 V. The inverter returns to running state once the voltage returns to the MPPT operating voltage range, namely, 40 V to 560 V.

5.6.1 PV Input Configuration

- The inverters SG2.0RS-S / SG2.5RS-S / SG3.0RS-S have one PV input with one MPP tracker.
- The inverters SG3.0RS / SG3.6RS / SG4.0RS / SG5.0RS / SG6.0RS have two PV inputs, each with independent MPP tracker. Each DC input area can operate independently.
- The PV strings to the same DC input area should have the same type, the same number of PV panels, identical tilt and identical orientation for maximum power.

- The PV strings to two DC input areas may differ from each other, including PV module type, number of PV modules in each string, angle of tilt, and installation orientation.

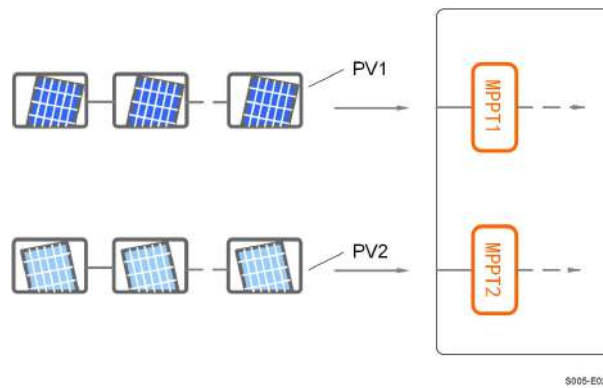

figure 5-3 PV Input Configuration (SG6.0RS for example)

Prior to connecting the inverter to PV inputs, the specifications in the following table should be met:

Inverter Model	Open-circuit Voltage Limit	Max. current for input connector
All models	600 V	20 A

5.6.2 Assembling the PV Connectors

⚠ DANGER

High voltage may be present in the inverter!

- Ensure all cables are voltage-free before performing electrical operations.
- Do not connect the AC circuit breaker before finishing electrical connection.



SUNGROW provides corresponding PV connectors in the scope of delivery for quick connection of PV inputs. To ensure IP65 protection, use only the supplied connector or the connector with the same ingress of protection.

step 1 Strip the insulation from each DC cable by 7 mm – 8 mm.

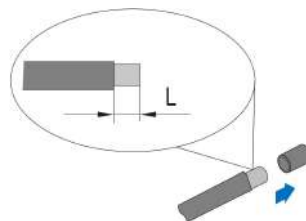

step 2 Assemble the cable ends with the crimping pliers.

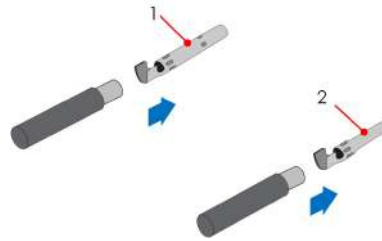

1: Positive crimp contact

2: Negative crimp contact

step 3 Lead the cable through cable gland, and insert the crimp contact into the insulator until it snaps into place. Gently pull the cable backward to ensure firm connection. Tighten the cable gland and the insulator (torque 2.5 N.m to 3 N.m).

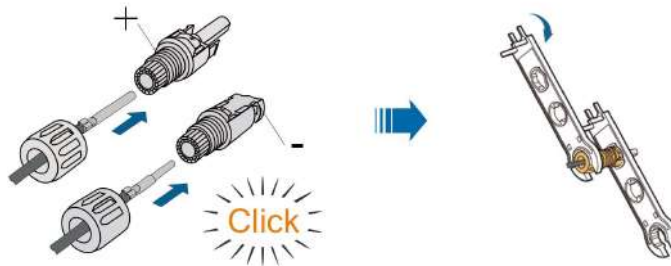

step 4 Check for polarity correctness.

NOTICE

If the PV polarity is reversed, the inverter will be in a fault or alarm state and will not operate normally.

-- End

5.6.3 Installing the PV Connectors

step 1 Rotate the DC switch to "OFF" position.

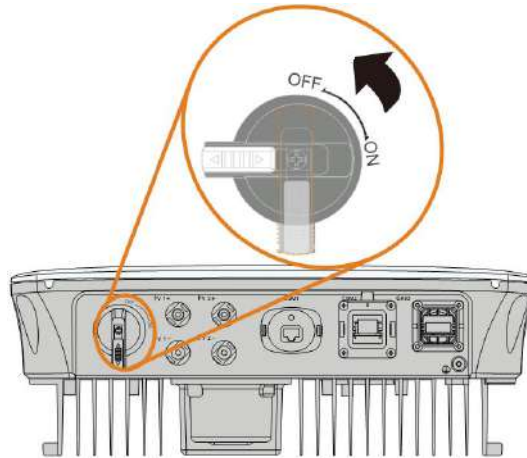

S005-E032

step 2 Check the cable connection of the PV string for polarity correctness and ensure that the open circuit voltage in any case does not exceed the inverter input limit of 600 V.

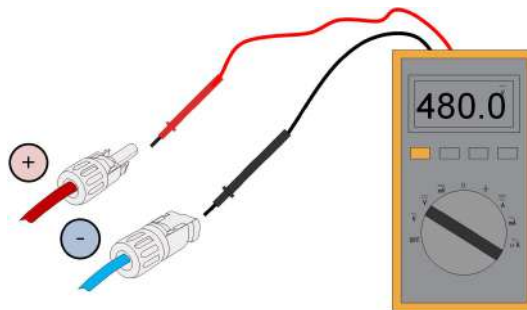

step 3 Connect the PV connectors to corresponding terminals until there is an audible click.

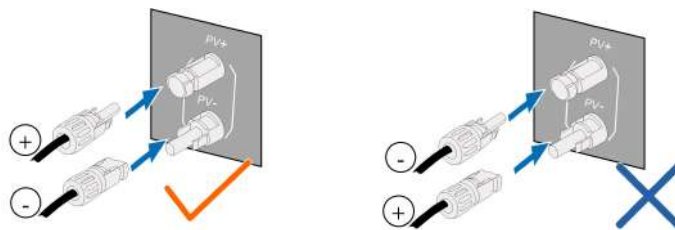

NOTICE

- Check the positive and negative polarity of the PV strings, and connect the PV connectors to corresponding terminals only after ensuring polarity correctness.
- Electric arc or contactor overtemperature may occur if the PV connectors are not firmly in place, and SUNGROW shall not be held liable for any damage caused due to this operation.

step 4 Seal the unused PV terminals with the terminal caps.

-- End

5.7 WiNet-S Connection

The WiNet-S module supports Ethernet communication and WLAN communication. It is not recommended to use both communication methods at the same time.

For details, see the quick guide for the WiNet-S module. Scan the following QR code for the quick guide.



5.7.1 Ethernet Communication

step 1 (Optional) Strip the insulation layer of the communication cable with an Ethernet wire stripper, and lead the corresponding signal cables out. Insert the stripped communication cable into the RJ45 plug in the correct order, and crimp it with a crimper.

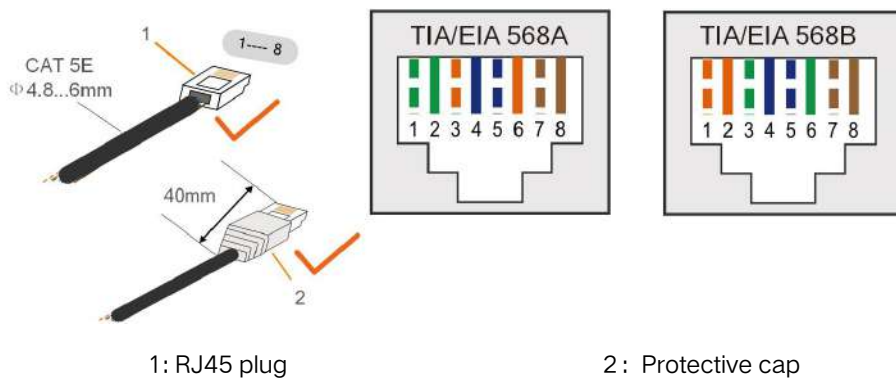

Skip this step if a standard network cable with RJ45 plug is prepared.

step 2 Unscrew the swivel nut from the communication module and take out the inner sealing ring.

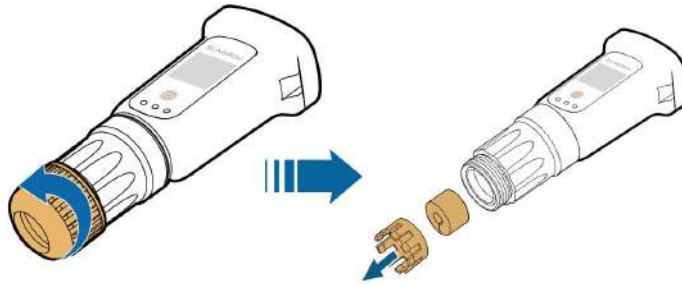

step 3 Unscrew the housing from the communication module.

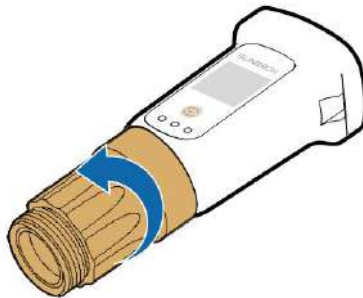

step 4 Thread the network cable through the swivel nut and gasket. Afterwards, route the cable into the opening of the sealing. Finally, insert the cable through the housing.

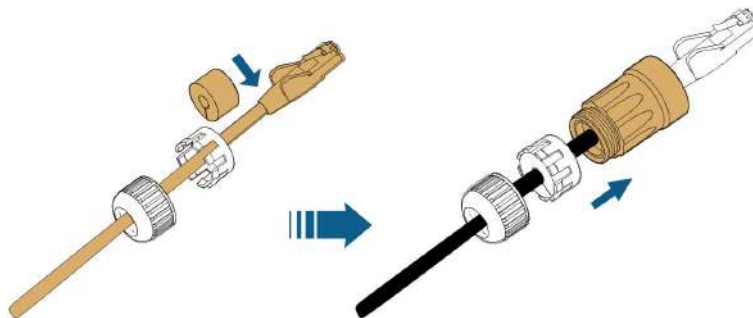

step 5 Insert the RJ45 plug into the front plug connector until there is an audible click and tighten the housing. Install the gasket and fasten the swivel nut.

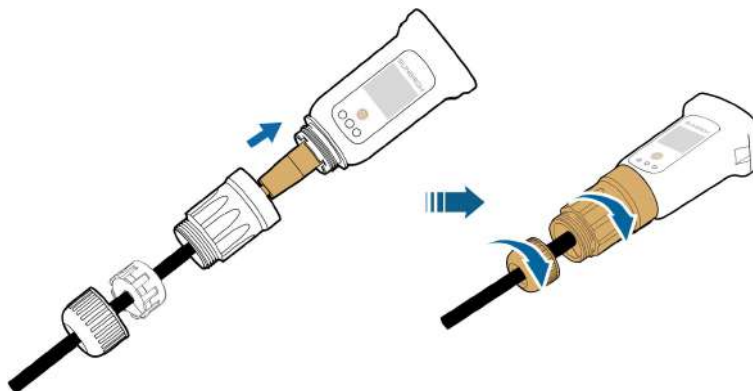

step 6 Remove the waterproof lid from the **COM1** terminal and install WiNet-S.

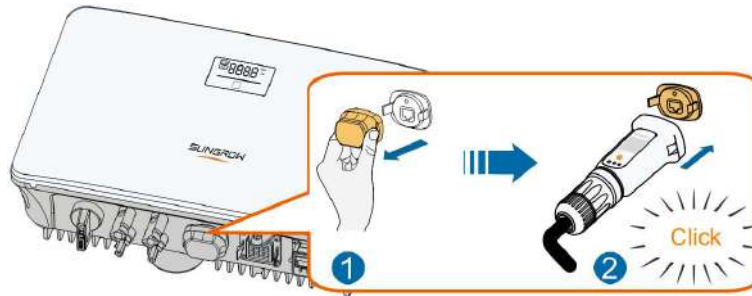

S005-E041

step 7 Slightly shake it by hand to determine whether it is installed firmly.

-- End

5.7.2 WLAN Communication

step 1 Remove the waterproof lid from the **COM1** terminal.

step 2 Install the module. Slightly shake it by hand to determine whether it is installed firmly, as shown below.

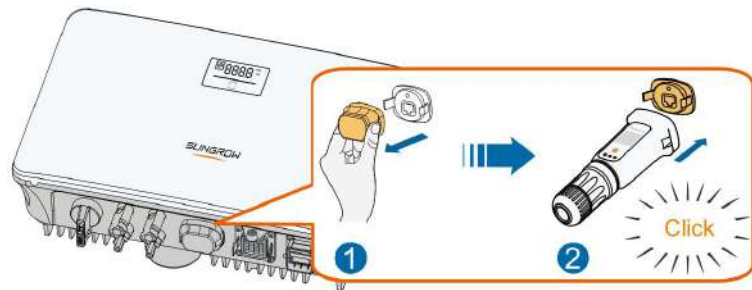

S005-E042

step 3 Refer to the guide delivered with the module for the set-up.

-- End

5.8 Meter Connection

step 1 Unscrew the swivel nut from the communication connector.

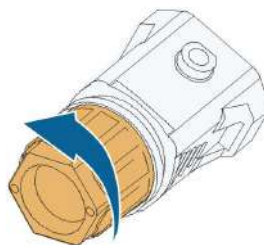

S005-E007

step 2 Remove the seal and lead the cable through the cable gland.

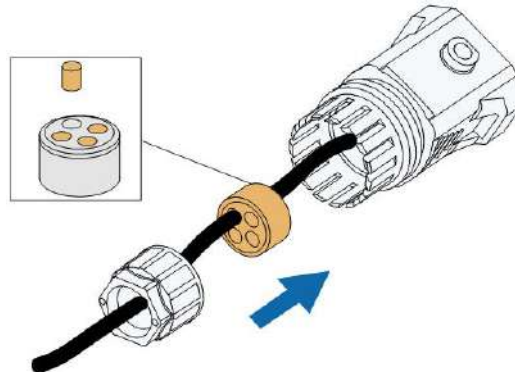

S005-E008

step 3 Remove the cable jacket and strip the wire insulation.

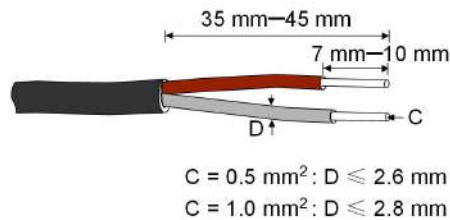

S005-E044

step 4 (Optional) When using a multi-core multi-strand wire cable, connect the wire head to the cord end terminal. In case of single-strand copper wire, skip this step.

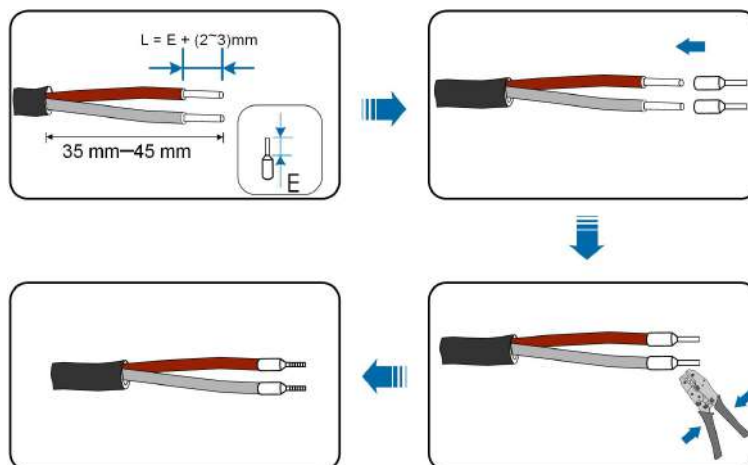

S005-E045

step 5 Plug the wires into the corresponding terminals as shown in the following figure. Ensure that the wires are securely in place by slightly pulling them.

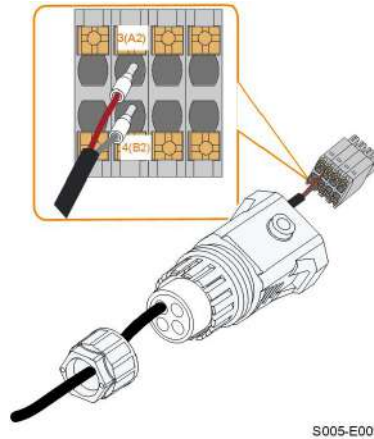

S005-E009

step 6 Insert the terminal plug into the **COM2** terminal at the bottom side of the inverter and then install the housing.

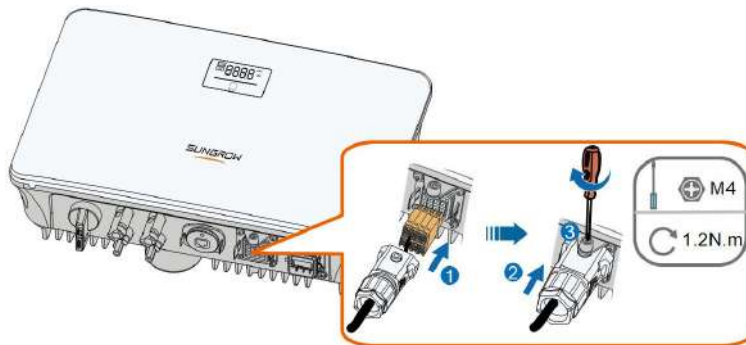

S005-E010

step 7 Slightly pull out the cable and then fasten the swivel nut. Lock the connector with the screw.

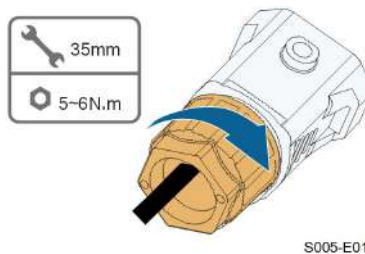

S005-E011

-- End

5.9 DRM Connection

In Australia and New Zealand, the inverter supports DRM0 as specified in the standard AS/NZS 4777.

The DRM0 mode is asserted by shorting terminals **R** and **C** on the inverter.

step 1 Unscrew the swivel nut from the communication connector.

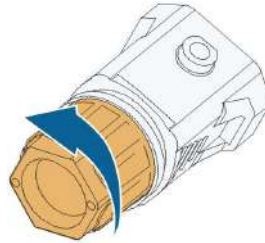

S005-E007

step 2 Remove the seal and lead the cable through the cable gland.

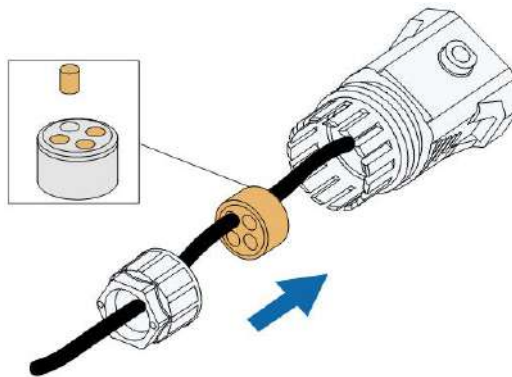

S005-E008

step 3 Remove the cable jacket and strip the wire insulation.

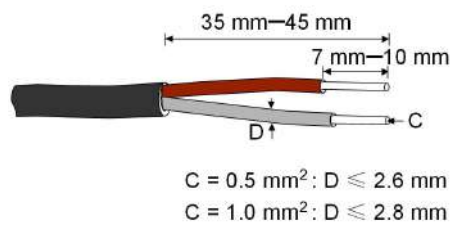

S005-E044

step 4 (Optional) When using a multi-core multi-strand wire cable, connect the wire head to the cord end terminal. In case of single-strand copper wire, skip this step.

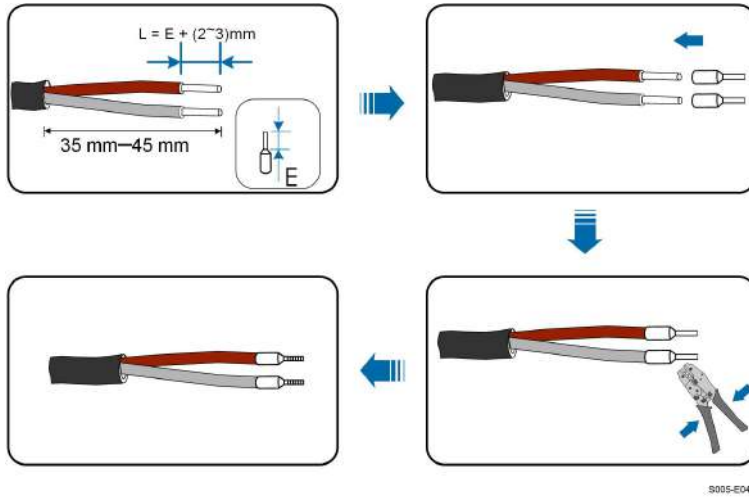

S005-E045

step 5 Plug the wires into the corresponding terminals as shown in the following figure. Ensure that the wires are securely in place by slightly pulling them.

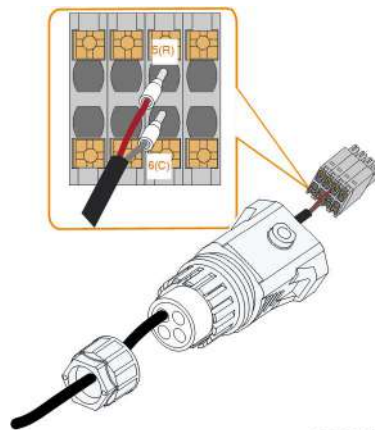

S005-E012

step 6 Insert the terminal plug into the COM2 terminal at the bottom side of the inverter and then install the housing.

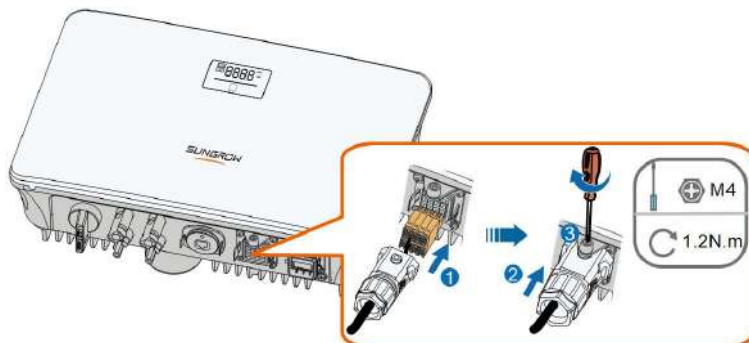

S005-E010

step 7 Slightly pull out the cable and then fasten the swivel nut. Lock the connector with the screw.

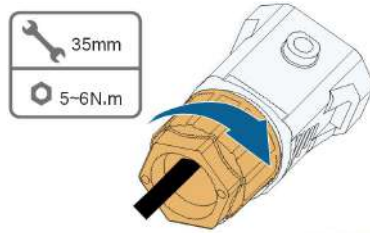

-- End

6 Commissioning

6.1 Inspection before Commissioning

Check the following items before starting the inverter:

- All equipment has been reliably installed.
- DC and AC switches are in the "OFF" position.
- The ground cable is properly and reliably connected.
- The AC cable is properly and reliably connected.
- The DC cable is properly and reliably connected.
- The communication cable is properly and reliably connected.
- The vacant terminals are sealed.
- No foreign items, such as tools, are left on the top of the machine or in the junction box (if there is).
- The AC circuit breaker is selected in accordance with the requirements of this manual and local standards.
- All warning signs & labels are intact and legible.

6.2 Powering on the System

If all of the items mentioned above meet the requirements, proceed as follows to start up the inverter for the first time.

step 1 Turn on the AC circuit breaker between the inverter and the grid.

step 2 Rotate the DC switch of the inverter to "ON" position.

step 3 Turn on the external DC switch (if applicable) between the inverter and the PV string.

step 4 If the irradiation and grid conditions meet requirements, the inverter will operate normally. Observe the LED indicator to ensure that the inverter operates normally. Refer to ["2.4 LED Panel"](#) for LED screen introduction and LED indicator definition.

step 5 Refer to the quick guide for WiNet-S for its indicator definition.

-- End

6.3 App Preparation

step 1 Install the iSolarCloud App with latest version. Refer to ["7.2 Installing the App"](#).

step 2 Register an account. Refer to "[7.3 Account Registration](#)". If you have got the account and password from the distributor/installer or SUNGROW, skip this step.

step 3 Download the firmware package to the mobile device in advance. Refer to "[7.10.5 Firmware Update](#)". This is to avoid download failure due to poor on-site network signal.

-- End

6.4 Creating a Plant

Screenshots of creating a plant are for reference only. For details, refer to the actual screen.

step 1 Open the App, tap  at the upper right corner and tap **Select Server**. Choose the same server as when registering.

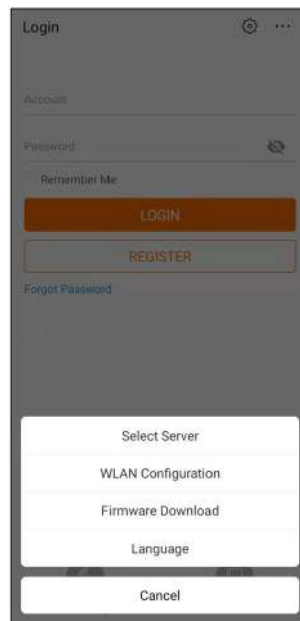

figure 6-1 Selecting the Server

step 2 Enter the account and password on the login screen and tap **Login** to enter the App home screen.

step 3 Tap the icon  at the upper right corner to enter the creating screen.



figure 6-2 Creating Power Plant

step 4 Select plant type to **RESIDENTIAL** and inverter type to **PV**.

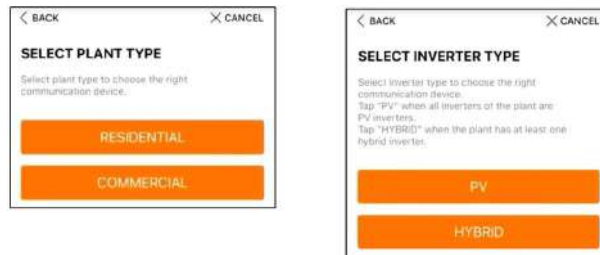

figure 6-3 Selecting Plant/Inverter Type

step 5 Scan the QR code on the communication device or manually enter the serial number of the communication device. Tap **Next** after the QR code is identified or the serial number entered is correct and then tap **CONFIRM**. Your mobile device is thus connected to the WiNet-S successfully.

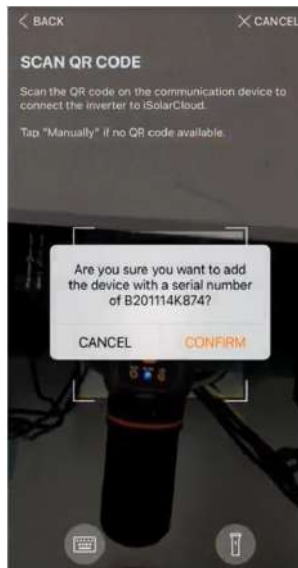

figure 6-4 Connecting Mobile Device to WiNet-S

step 6 Select the Internet access mode to **WLAN(CONNECTED)** or **ETHERNET** according to actual connection. The following description is for WLAN access mode.



figure 6-5 Selecting Internet Access Mode

step 7 The **EASYCONNECT INSTRUCTION** screen will prompt. Press the multi-function button on the WiNet-S module once to turn on EasyConnect mode. The WLAN indicator on WiNet-S blinks quickly when this mode is turned on. Return to the App and the screen displays successful connection to the inverter WLAN. Tap **NEXT**.

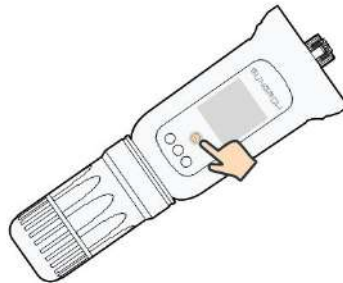

figure 6-6 Turn on EasyConnect Mode

NOTICE

The EasyConnect mode can be used only when the router is 2.4 GHz.
If the EasyConnect mode fails, refer to the WiNet-S quick guide for the instructions of other modes.

step 8 Connect the inverter to router network. Enter network name and password. Tap **NEXT** and the screen display prompt information of successful connection to the router network.

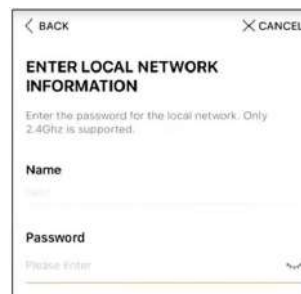

figure 6-7 Connecting Inverter to Router Network

-- End

6.5 Initializing the Device

The inverter is successfully connected to the router.

If there is no latest equipment upgrade package, skip steps 1 and 2.

The actual initializing procedure may differ due to different countries. Please follow the actual App guidance.

step 1 If a latest equipment upgrade package is available, the following prompt window pops up. Tap **UPDATE NOW** to download the latest update package.

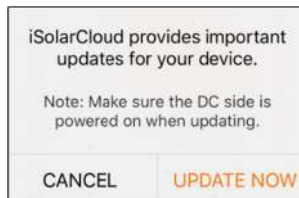

figure 6-8 Upgrade Reminder

step 2 After download, it would take around 15 minutes to update. After successful upgrade, the screen will show the version numbers before and after the upgrade as well as the upgrade time. Tap **NEXT**.

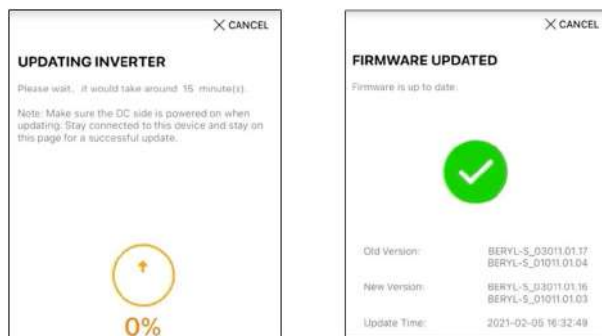

figure 6-9 Upgrading Inverter

NOTICE

If the communication equipment is upgraded, after successful upgrade, check and confirm that the phone is connected to the inverter WLAN.

step 3 Tap **Country/Region** and select the country where the inverter is installed at. The supported countries and corresponding settings are as follows.

Country/Region	Setting
Belgium ("BE")	Belgium
Netherlands ("NL")	Netherlands
Portugal / Turkey / Hungary	EN50549-1

Country/Region	Setting
Australia ("AU")	Australia
New Zealand ("NZ")	New Zealand
Countries not listed above	Other 50Hz or Other 60Hz

NOTICE

The parameter **Country/Region** must be set to the country (region) where the inverter is installed at. Otherwise, the inverter may report errors.

step 4 When the country is set to Australia, additionally set the applicable network service provider and then the grid type.

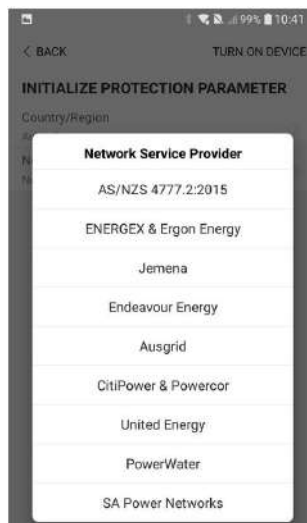

The image shown here is for reference only. Refer to the actual interface for the supported network service providers.

table 6-1 Description of Network Service Provider and Grid Type

Network Service Provider	Grid Type
AS/NZS 4777.2:2015	/
ENERGEX & Ergon Energy	<ul style="list-style-type: none"> • STNW1170: single-phase < 10 kVA & three-phase < 30 kVA • STNW1174: 30 kVA < $P_n \leq 1500$ kVA
Jemena	<ul style="list-style-type: none"> • ≤ 10 kVA per phase (or 30 kVA per three phase) • ELE GU 0014: 30 kVA – 200 kVA
Endeavour Energy	MDI 0043

Network Service Provider	Grid Type
Ausgrid	NS194
CitiPower & Powercor	<ul style="list-style-type: none"> • ≤ 5 kVA for single-phase & 30 kVA for three-phase • > 30 kVA three-phase
United Energy	<ul style="list-style-type: none"> • UE-ST-2008.1: ≤ 10 kVA for single-phase & 30 kVA for three-phase • UE-ST-2008.2: > 30 kVA three-phase
PowerWater	AS/NZS 4777.2:2015
SA Power Networks	<ul style="list-style-type: none"> • TS129-2019: < 10 kW for single-phase & 30 kW for three-phase • TS130-2017: > 30 kW & ≤ 200 kW • TS131-2018: > 200 kW

step 5 Initialize parameters according to local grid requirements, including grid type, reactive power regulation mode, etc. The screen displays that the inverter is successfully configured.

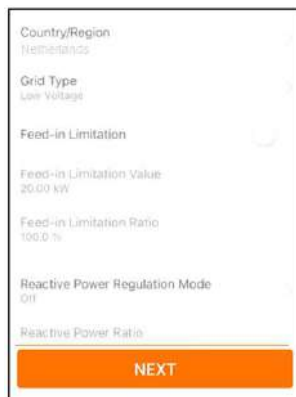

figure 6-10 Initializing Parameters

-- End

6.6 Configuring the Plant

The inverter is successfully added to the plant and initialized. Refer to the guidance in previous sections.

The distributor/installer who creates a plant for the end user needs to get the end user's e-mail address. In configuring a plant, the e-mail address is required, and each e-mail address can be registered only once.

step 1 The App screen will display the added inverter. Tap **NEXT** to configure the plant.

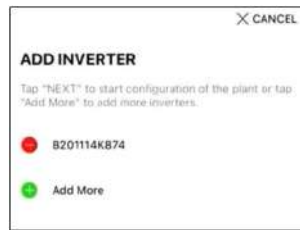

figure 6-11 Display the Added Inverter

step 2 Fill in the plant information. The fields marked with * must be filled in.

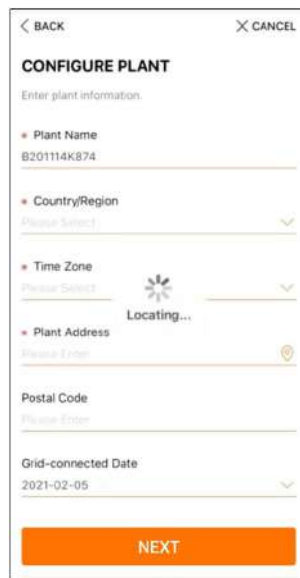

figure 6-12 Entering Plant Information

step 3 (Optional) Fill in the tariff information. The electricity price can be set to a specific value or Time-of-Use tariff.

figure 6-13 Entering Tariff Information

step 4 Fill in the end user's e-mail address. The first time you fill in the end user's e-mail address, the system will create an account for the end user and send an email to the end user. The end user can activate the account via the email.



The Distributor/installer creates plants for the end user and can manage the plants by default.

figure 6-14 Entering Owner's e-mail

step 5 Tap **NEXT** to wait for the inverter to connect to the iSolarCloud.

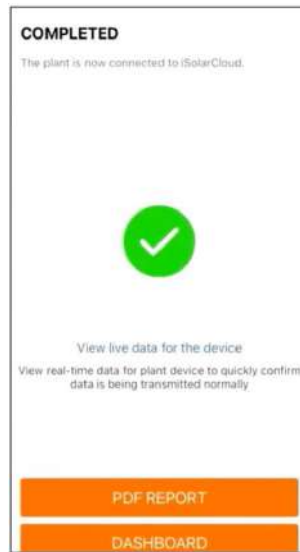

figure 6-15 Configuration Completed

step 6 (Optional) Tab **View live data for the device**, tick **Inverter** or **Total Plant Devices** and tab **ALL PLANTS OPEN**. The clock symbol indicates that the live data view function is successfully enabled. Tab the inverter to view the live data about voltage, current, power or curve.

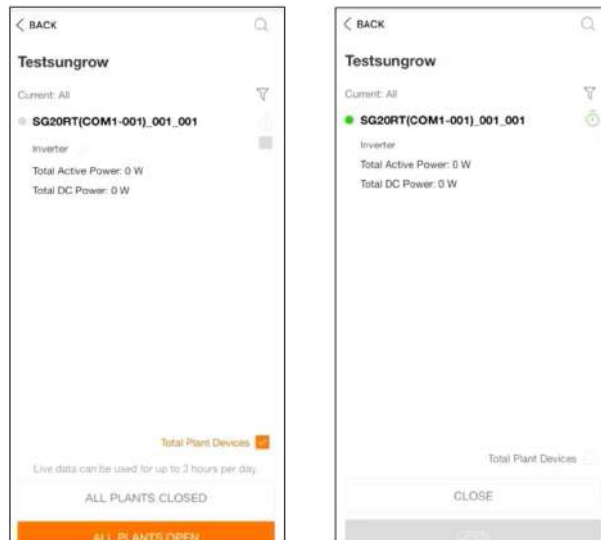

figure 6-16 Live Data View Function Setting



Consult Sungrow service for the devices that support live data function.

step 7 Tab **BACK** to the **COMPLETED** screen. Tab **PDF REPORT** to export the plant configuration report.

step 8 Tab **BACK** to the **COMPLETED** screen. Tab **DASHBOARD** to return and manually refresh the page until the newly created plant is displayed with status commissioned.

-- End

7 iSolarCloud App

7.1 Brief Introduction

The iSolarCloud App can establish communication connection to the inverter via the WLAN, providing remote monitoring, data logging and near-end maintenance on the inverter. Users can also view inverter information and set parameters through the App.

* To achieve direct login via WLAN, the wireless communication module developed and manufactured by SUNGROW is required. The iSolarCloud App can also establish communication connection to the inverter via Ethernet connection.



- This manual describes only how to achieve near-end maintenance via WLAN direct connection.
- Screenshots in this manual are based on the V2.1.6 App for Android system, and the actual interfaces may differ.

7.2 Installing the App

Method 1

Download and install the App through the following application stores:

- MyApp (Android, mainland China users)
- Google Play (Android, users other than mainland China ones)
- App Store (iOS)

Method 2

Scan the following QR code to download and install the App according to the prompt information.



The App icon appears on the home screen after installation.



7.3 Account Registration

The account distinguishes two user groups, end user and distributor/installer.

- The end user can view plant information, create plants, set parameters, share plants, etc.
- The distributor/installer can help the end user to create plants, manage, install, or maintain plants, and manage users and organizations.

step 1 Tap **REGISTER** to enter the registration screen.

USER REGISTRATION

Account Type

BASE Plant

Please select the relevant server for your area; if not available, please select the international station

Distributor/Installer

Distributor/Installer is the person who install or/and manage the plant, and supply service to end user

End User

End User is the person who will own or has owned one inverter or more

step 2 Select the relevant server for your area.

step 3 Select **End user** or **Distributor/Installer** to enter the corresponding screen.

DISTRIBUTOR/INSTALLER

Email @gmail.com

[Send Verification Code](#) 

Verification Code

Password

Confirm Password

Country/Region

Company Name

Code of Upper Level Installer/Distributor

[Accept Privacy Policy](#)

step 4 Fill in the registration information, including email, verification code, password and affirmation and country (region). The distributor/installer has the permission to fill in the company name and the code of upper level distributor/installer.



The code of upper level distributor/installer can be obtained from the upper level distributor/installer. Only when your organization belongs to the upper level distributor/installer organization, can you fill in the corresponding code.

step 5 Tick **Accept privacy protocol** and tap **Register** to finish the registration operation.

-- End

7.4 Login

7.4.1 Requirements

The following requirements should be met:

- The AC and DC sides or the AC side of the inverter is powered-on.
- The WLAN function of the mobile phone is enabled.
- The mobile phone is within the coverage of the wireless network produced by the communication module.

7.4.2 Login Procedure

step 1 For the WiNet-S module, press the multi-function button 3 times to enable the WLAN hotspot. No password is required and the valid time is 30 minutes.

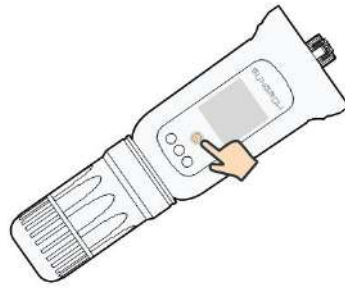

figure 7-1 Enabling the WLAN Hotspot

step 2 Connect the mobile phone to the WLAN network named as "SG-xxxxxxxx" (xxxxxxxx is the serial number indicated on the side of the communication module).

step 3 Open the App to enter the login screen. Tap **Local Access** to enter the next screen.

step 4 Select **WLAN** and select the device (SN), then enter the password and tap **LOGIN**.



The default account is "user" and the initial password is "pw1111" which should be changed for the consideration of account security. Tap "More" at the lower right corner on home page and choose "Change Password".

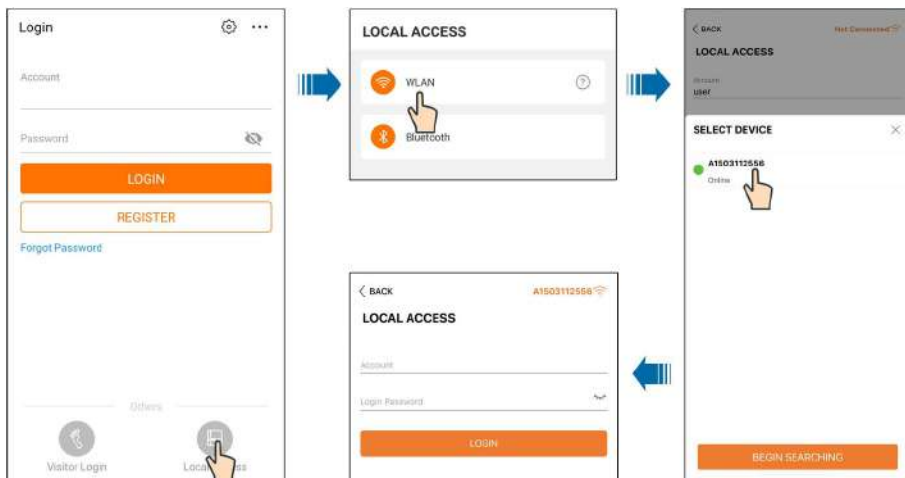

figure 7-2 WLAN Local Access

step 5 If the inverter is not initialized, navigate to the quick setting screen to initialize the protection parameters. For details, please refer to "**Initial Settings**".

NOTICE

The "Country/Region" must be set to the country where the inverter is installed at. Otherwise, the inverter may report errors.

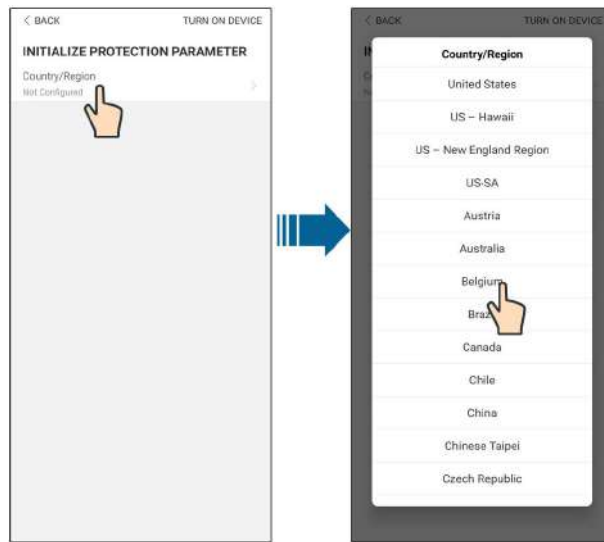

figure 7-3 WLAN Local Access

step 6 After finishing the settings, tap **TURN ON DEVICE** at the upper right corner and the device will be initialized. The App will send start instructions and the device will start and operate.

step 7 After initialization settings, the App will return automatically to the home page.

-- End

7.5 Initial Settings

Tap **Country/Region** and select the country where the inverter is installed. For countries except Australia and Germany, the initialization is completed.



The actual initializing procedure may differ due to different countries. Please follow the actual App guidance.

For some countries, you should initialize parameters according to local grid requirements. For details, see "[6.5 Initializing the Device](#)".

7.6 Function Overview

The App provides parameter viewing and setting functions, as shown in the following figure.

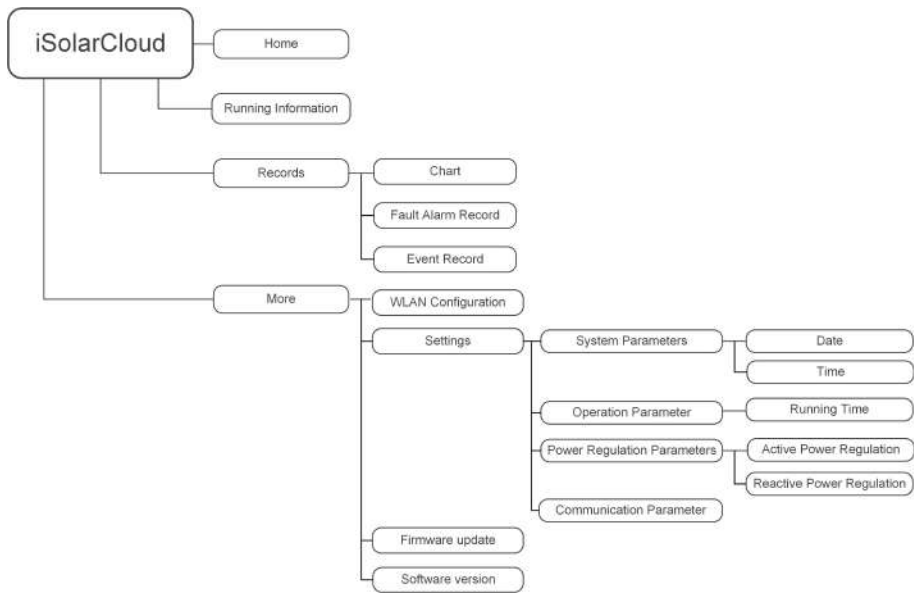

figure 7-4 App Key Function Menu

7.7 Home

Home page of the App is shown in the following figure.

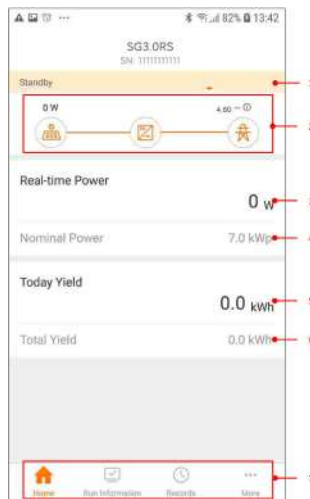



figure 7-5 Home

table 7-1 Home Page Description

No.	Name	Description
1	Inverter state	Present operation state of the inverter
2	Energy flow chart	Shows the PV power generation power, feed-in power, etc. The line with an arrow indicates energy flow between connected devices, and the arrow pointing indicates energy flow direction.
3	Real-time power	Shows the present output power of the inverter.
4	Nominal power	Shows the installed power of the inverter.
5	Today yield	Shows today power generation of the inverter
6	Total yield	Shows accumulative power generation of the inverter
7	Navigation bar	Includes menus of "Home", "Run Information", "Records" and "More".

If the inverter runs abnormally, the fault icon  will appear on the upper left corner of the screen. Users can tap the icon to view detailed fault information and corrective measures.

7.8 Run Information

Tap **Run Information** on the navigation bar to enter the screen showing running information, slide the screen upwards to view all detailed information.

table 7-2 Description of Run Information

Item	Description
PV information	Shows voltage and current of every PV string.
Inverter information	Shows basic information such as running state, on-grid running time, negative voltage to grid, bus voltage, internal air temperature, inverter efficiency, etc.
Input	Shows total DC power, voltage and current of MPPT1 and MPPT2.
Output	Shows daily/monthly/annual/total yield, total active/reactive/ap-parent power, total power factor, grid frequency, phase voltage and current.
Meter information	Shows active power and phase active power of the meter.

7.9 Records

Tap **Records** on the navigation bar to enter the screen showing event records, as shown in the following figure.

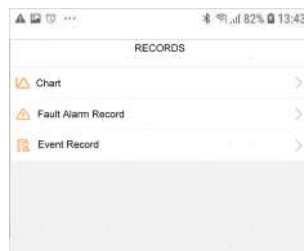
**figure 7-6** Records

Chart

Tap **Chart** to enter the screen showing daily power generation, as shown in the following figure.



figure 7-7 Chart

The App displays power generation records in a variety of forms, including daily power generation graph, monthly power generation histogram, annual power generation histogram and total power generation histogram.

table 7-3 Description of Power Curve

Item	Description
Daily	Daily curve that indicates the real-time power.
Month	Monthly curve that indicates daily yield and equivalent hours in a month.
Year	Annual curve that indicates monthly yield and equivalent hours in a year.
Total	A curve that indicates annual yield and equivalent hours since installation.

Fault Alarm Record

Tap **Fault Alarm Record** to enter the screen, as shown in the following figure.



figure 7-8 Fault Alarm Record



Click  to select a time segment and view corresponding records.

Select one of the records in the list and click the record, to view the detailed fault info as shown in following figure.



figure 7-9 Detailed Fault Alarm Information

Event Record

Tap **Event Record** to enter the screen, as shown in the following figure.

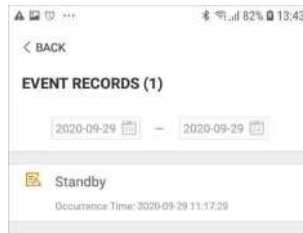



figure 7-10 Event Record



Click  to select a time segment and view corresponding records.

7.10 More

Tap **More** on the navigation bar to enter the corresponding screen, as shown in the following figure.

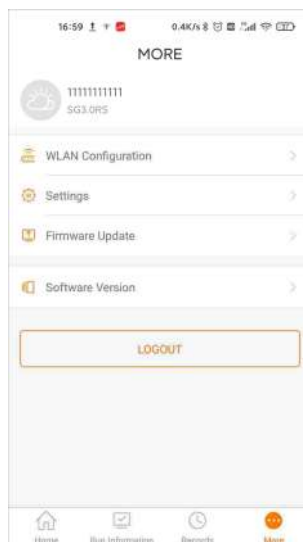

figure 7-11 More

In addition to viewing the WLAN configuration and App software version, the **More** screen supports the following operations:

- Set parameters including inverter system parameters, operation parameters, power regulation parameters and communication parameters.
- Upgrade inverter firmware.

7.10.1 System Parameters

Tap **Settings**→**System Parameters** to enter the corresponding screen, as shown in the following figure.



figure 7-12 System Parameters

Boot/Shutdown

Tap **Boot/Shutdown** to send the boot/shutdown instruction to the inverter.

For Australia and New Zealand, when the DRM state is DRM0, the "Boot" option will be prohibited.

Date/Time

The correct system time is very important. Wrong system time will directly affect the data logging and power generation value. The clock is in 24-hour format.

7.10.2 Operation Parameters

Running Time

Tap **Settings**→**Operation Parameters**→**Running Time** to enter the corresponding screen, on which you can set "Connecting Time" and "Reconnecting Time".



figure 7-13 Running Time

PID Parameters

Tap **Settings**→**Operation Parameters**→**PID Parameters** to enter the corresponding screen, on which you can set "PID Parameters".

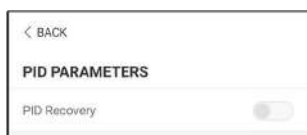

figure 7-14 PID Setting

table 7-4 PID Parameter Description

Parameter	Description
PID Recovery	Set enabling/disabling of the PID night recovery function. PID night recovery function operates between 22:00 pm and 5:00 am by default.

AFCI Parameters(Optional)

Tap **Settings**→**Operation Parameters**→**AFCI Parameters** to enter the corresponding screen, on which you can set "AFCI Parameters".

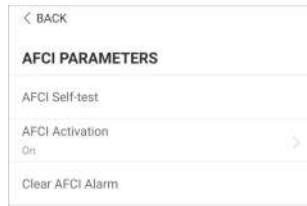

figure 7-15 AFCI Setting

7.10.3 Power Regulation Parameters

Active Power Regulation

Tap **Settings**→**Power Regulation Parameters**→**Active Power Regulation** to enter the screen, as shown in the following figure.

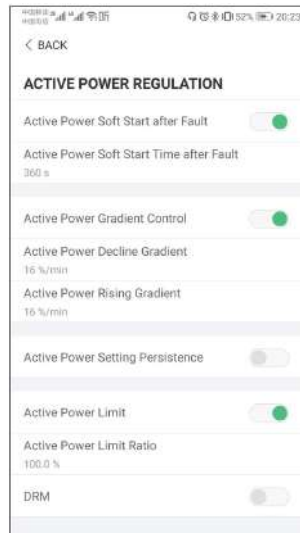

figure 7-16 Active Power Regulation

table 7-5 Description of Active Power Regulation Parameters

Parameter	Description	Range
Active Power Soft Start after Fault	Switch for activating/deactivating the function of active power soft start after a fault occurs	On/Off
Active Power Soft Start Time after Fault	The soft start time required for raising active power from 0 to rated value after a fault occurs	1 s – 1200 s
Active Power Gradient Control	Set whether to enable active power gradient control	On/Off

Parameter	Description	Range
Active Power Decline Gradient	Decline gradient of inverter active power per minute	3 %/min – 6000
Active Power Rising Gradient	Rising gradient of inverter active power per minute	%/min
Active Power Setting Persistence	Switch for activating/deactivating the function of active power setting persistence	On/Off
Active Power Limit	Switch for limiting active power	On/Off
Active Power Limit Ratio	The ratio of active power limit to rated power in percentage	0.0 % – 110.0 %
DRM	Switch for activating/deactivating the DRM function	On/Off

Reactive Power Regulation

Tap **Settings**→**Power Regulation Parameters**→**Reactive Power Regulation** to enter the screen, as shown in the following figure.



figure 7-17 Reactive Power Regulation

table 7-6 Description of Reactive Power Regulation Parameters

Parameter	Description	Range
Reactive Power Setting Persistence	Switch for activating/deactivating the function of reactive power setting persistence	On/Off
Reactive Power Regulation Mode	Off/PF/Qt/Q(P)/Q(U)	Off/PF/Qt/Q(P)/Q(U)
Reactive Response	Switch for activating/deactivating the function of reactive response	On/Off
Reactive Response Time	Time for reactive response	0.2 s

"Off" Mode

The reactive power regulation function is disabled. The PF is fixed at +1.000.

"PF" Mode

The power factor (PF) is fixed and the reactive power is regulated by the parameter PF. The PF ranges from 0.8 leading to 0.8 lagging.

- Leading: the inverter is sourcing reactive power to the grid.
- Lagging: the inverter is injecting reactive power into the grid.

"Qt" Mode

In the Qt mode, the reactive power can be regulated by the parameter Q-Var limits (in %). The system rated reactive power is fixed, the system injects reactive power according to the delivered reactive power ratio. The "Reactive Power Ratio" is set through the App.

The setting range of the reactive power ratio is from -100 % to 100 %, corresponding to the ranges of inductive and capacitive reactive power regulation respectively.

"Q(P)" Mode

The PF of the inverter output varies in response to the output power of the inverter.

table 7-7 "Q(P)" Mode Parameters Explanation

Parameter	Explanation	Range
Q(P) Curve	Select corresponding curve according to local regulations	A, B, C*
QP_P1	Output power at point P1 on the Q(P) mode curve (in %)	20.0 % – 100.0 %
QP_P2	Output power at point P2 on the Q(P) mode curve (in %)	20.0 % – 100.0 %
QP_P3	Output power at point P3 on the Q(P) mode curve (in %)	20.0 % – 100.0 %
QP_K1	Power factor at point P1 on the Q(P) mode curve	Curve A/C: 0.800 to 1.000 Curve B: -0.600 to 0.600
QP_K2	Power factor at point P2 on the Q(P) mode curve	
QP_K3	Power factor at point P3 on the Q(P) mode curve	
QP_EnterVoltage	Voltage for Q(P) function activation (in %)	100.0 % – 110.0 %
QP_ExitVoltage	Voltage for Q(P) function deactivation (in %)	90.0 % – 100.0 %
QP_ExitPower	Power for Q(P) function deactivation (in %)	1.0 % – 20.0 %
QP_EnableMode	Unconditional activation/deactivation of Q(P) function	Yes, No

* Curve C is reserved and consistent with Curve A currently.

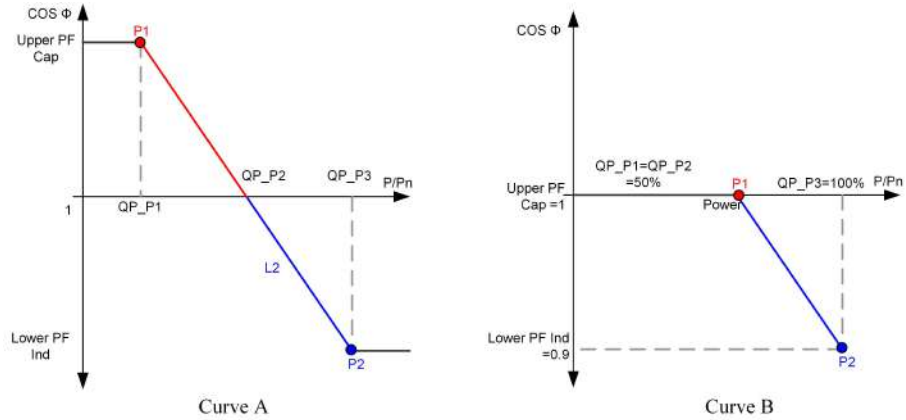

figure 7-18 Reactive Power Regulation Curve in Q(P) Mode

"Q(U)" Mode

The reactive power output of the inverter varies in response to the grid voltage.

table 7-8 "Q(U)" Mode Parameter Explanation

Parameter	Explanation	Range
Q(U) curve	Select corresponding curve according to local regulations	A, B, C*
Hysteresis Ratio	Voltage hysteresis ratio on the Q(U) mode curve	0.0 % – 5.0 %
QU_V1	Grid voltage limit at point P1 on the Q(U) mode curve (in %)	80.0 % – 100.0 %
QU_V2	Grid voltage limit at point P2 on the Q(U) mode curve (in %)	80.0 % – 110.0 %
QU_V3	Grid voltage limit at point P3 on the Q(U) mode curve (in %)	100.0 % – 120.0 %
QU_V4	Grid voltage limit at point P4 on the Q(U) mode curve (in %)	100.0 % – 120.0 %
QU_Q1	Value of Q/Sn at point P1 on the Q(U) mode curve (in %)	-60.0 % to 0.0 %
QU_Q2	Value of Q/Sn at point P2 on the Q(U) mode curve (in %)	-60.0 % to 60.0 %
QU_Q3	Value of Q/Sn at point P3 on the Q(U) mode curve (in %)	-60.0 % to 60.0 %

Parameter	Explanation	Range
QU_Q4	Value of Q/Sn at point P4 on the Q(U) mode curve (in %)	0.0 % to 60.0 %
QU_EnterPower	Active power for Q(U) function activation (in %)	20.0 % – 100.0 %
QU_ExitPower	Active power for Q(U) function deactivation (in %)	1.0 % – 20.0 %
QU_EnableMode	Unconditional activation/deactivation of Q(U) function	Yes, No, Yes (Limited by PF)
QU_Limited PF Value	Preset PF value	0 – 0.95

* Curve C is reserved and consistent with Curve A currently.

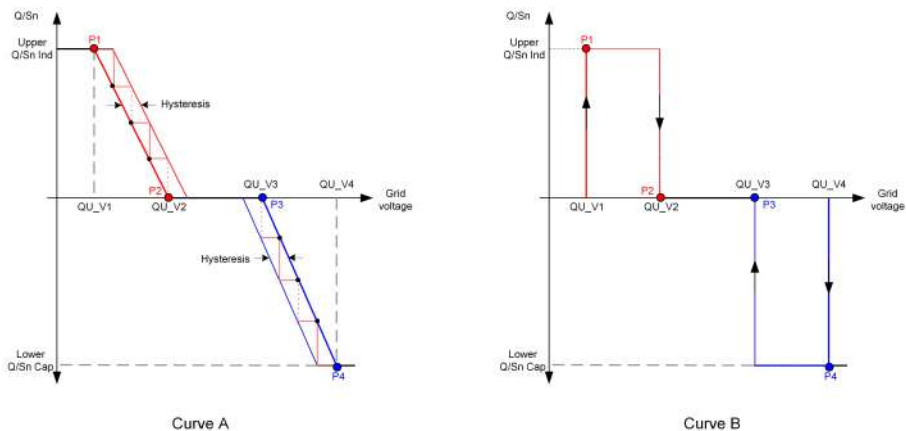

figure 7-19 Reactive Power Regulation Curve in Q(U) Curve

7.10.4 Communication Parameters

Tap **Settings**→**Communication Parameters** to enter the corresponding screen, as shown in the following figure. The device address ranges from 1 to 246.



figure 7-20 Communication Parameters

7.10.5 Firmware Update

To avoid download failure due to poor on-site network signal, it is recommended to download the firmware package to the mobile device in advance.

step 1 Enable the "Mobile data" of the mobile device.

step 2 Open the App, tap  at the upper right corner and select **Firmware Download**.

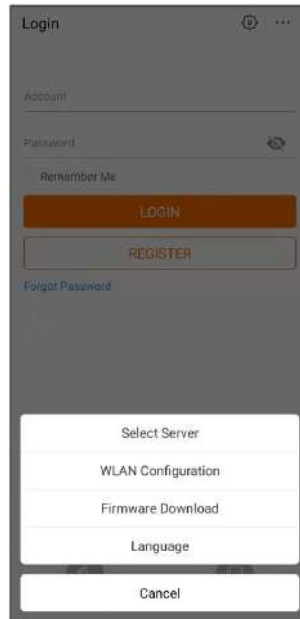

figure 7-21 Firmware Download

step 3 Select the firmware from the file list and download. Tap **Downloaded** to view successfully downloaded firmware package.

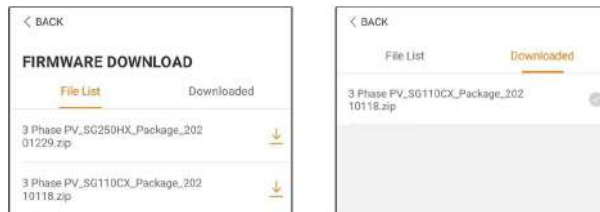

figure 7-22 Downloading Firmware Package

step 4 Login the App via local access mode. Refer to "[7.4 Login](#)".

step 5 Tab **More** on the App home screen and then tab **Firmware Upgrade**. Select the desired upgrade package to upgrade the firmware.

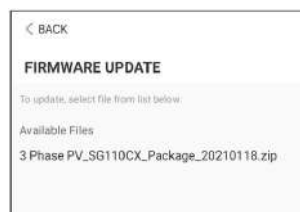

figure 7-23 Updating Firmware

-- End

8 System Decommissioning

8.1 Disconnecting the Inverter

For maintenance or other service work, the inverter must be switched off.

Proceed as follows to disconnect the inverter from the AC and DC power sources. Lethal voltages or damage to the inverter will follow if otherwise.

step 1 Disconnect the external AC circuit breaker and secure it against reconnection.

step 2 Rotate the DC switch to the "OFF" position for disconnecting all of the PV string inputs.

step 3 Wait about 10 minutes until the capacitors inside the inverter completely discharge.

step 4 Ensure that the DC cable is current-free via a current clamp.

step 5 Insert a MC4 wrench into the notch and press the wrench with an appropriate force to remove the DC connector.

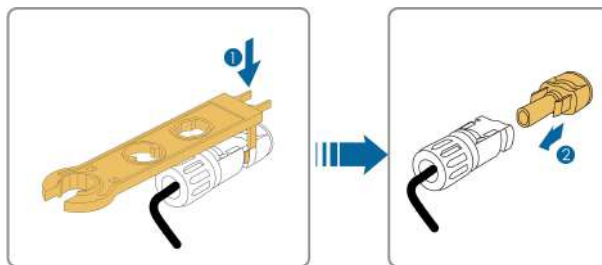

step 6 Lay the tool in the location of snap and press the tool down to remove the AC connector. Ensure that the AC wiring terminals are voltage-free via a multimeter, and remove the AC wires and communication wires.

step 7 Install the MC4 waterproof plugs.



For further disconnection and reconnection instructions, please visit the webpage of respective component manufacturer.

-- End

8.2 Dismantling the Inverter

CAUTION

Risk of burn injuries and electric shock!

Do not touch any inner live parts until for at least 10 minutes after disconnecting the inverter from the utility grid and the PV input.

- step 1** Refer to "[5 Electrical Connection](#)" for the inverter disconnection of all cables in reverse steps.
- step 2** Dismantle the inverter referring to "[4 Mechanical Mounting](#)" in reverse steps.
- step 3** If necessary, remove the wall-mounting bracket from the wall.
- step 4** If the inverter will be reinstalled in the future, please refer to "[3.2 Inverter Storage](#)" for a proper conservation.
- - End

8.3 Disposal of the Inverter

Users take the responsibility for the disposal of the inverter.

NOTICE

Some parts and devices of the inverter, such as the capacitors, may cause environmental pollution.

Do not dispose of the product together with household waste but in accordance with the disposal regulations for electronic waste applicable at the installation site.

9 Troubleshooting and Maintenance

9.1 Troubleshooting

When an error or an alarm occurs, the code will be displayed both on the LCD screen and the App.

The ID and corrective measures are as follows:

Alarm ID	Alarm Name	Corrective Measures
002, 003, 014	Grid overvoltage	<p>Generally, the inverter will be reconnected to the grid after the grid recovers. If the alarm occurs frequently:</p> <ol style="list-style-type: none">1. Measure the grid voltage, and contact the local utility grid company for solutions if the grid voltage exceeds the specified value.2. Check, through the App, whether the protection parameters are appropriately set.3. Check whether the cross-sectional area of the AC cable meets the requirement.4. If the alarm persists, contact SUNGROW.
004	Grid undervoltage	<p>Generally, the inverter will be reconnected to the grid after the grid recovers. If the alarm occurs frequently:</p> <ol style="list-style-type: none">1. Measure the grid voltage, and contact the local utility grid company for solutions if the grid voltage is below the specified value.2. Check, through the App, whether the protection parameters are appropriately set.3. Check whether the AC cable is firmly in place.4. If the alarm persists, contact SUNGROW.

Alarm ID	Alarm Name	Corrective Measures
008	Grid overfrequency	<p>Generally, the inverter will be reconnected to the grid after the grid recovers. If the alarm occurs frequently:</p> <ol style="list-style-type: none"> 1. Measure the grid frequency, and contact the local utility grid company for solutions if the grid frequency is beyond the specified range.
009	Grid underfrequency	<ol style="list-style-type: none"> 2. Check, through the App, whether the protection parameters are appropriately set. 3. If the alarm persists, contact SUNGROW.
010	Grid Power Outage	<p>Generally, the inverter will be reconnected to the grid after the grid recovers. If the alarm occurs frequently:</p> <ol style="list-style-type: none"> 1. Check whether the grid supplies power reliably. 2. Check whether the AC cable is firmly in place. 3. Check whether the AC cable is correctly connected (whether the live wire and the N wire are in correct place). 4. Check whether the AC switch or circuit breaker is disconnected. 5. If the alarm persists, contact SUNGROW.
012	Overhigh leakage current	<ol style="list-style-type: none"> 1. The alarm can be caused by poor sunlight or damp environment, and the inverter will be reconnected to the grid after the environment is improved. 2. If the environment is normal, check whether the AC and DC cables are well insulated. 3. If the alarm persists, contact SUNGROW.
013	Grid abnormal	<p>Generally, the inverter will be reconnected to the grid after the grid recovers. If the alarm occurs frequently:</p> <ol style="list-style-type: none"> 1. Measure the grid frequency, and contact the local utility grid company for solutions if the grid frequency exceeds the specified value. 2. If the alarm persists, contact SUNGROW.

Alarm ID	Alarm Name	Corrective Measures
028, 029	PV reverse connection fault	<ol style="list-style-type: none"> 1. Check whether the corresponding string is of reverse polarity. If so, disconnect the DC switch and adjust the polarity when the solar radiation is low and the string current drops below 0.5A. 2. If the fault is not caused by the foregoing reasons and still exists, please contact Sungrow Service.
037	Excessively high ambient temperature	<ol style="list-style-type: none"> 1. Check whether the inverter is directly exposed to sunlight. If so, take some shading measures. 2. Check and clean the air ducts. 3. Check whether the sub-alarm ID 070 (fan alarm) occurs through the App. If so, replace the faulty fan. 4. If the alarm persists, contact SUNGROW.
043	Excessively low ambient temperature	<ol style="list-style-type: none"> 1. Stop and disconnect the inverter. 2. Restart the inverter when the ambient temperature is within the permissible range.
039	Low system insulation resistance	<p>Wait for the inverter to recover. If the fault occurs frequently:</p> <ol style="list-style-type: none"> 1. Check whether the ISO resistance protection value is excessively high via the APP or the LCD, and ensure that it complies with the local regulations. 2. Check the resistance to ground of the string and DC cable. Take correction measures in case of short circuit or damaged insulation layer. 3. If the cable is normal and the fault occurs on rainy days, check it again when the weather turns fine. 4. If the fault occurs on a cloudy day without rain but there is stagnant water or vegetation on site, clear the water and vegetation. If the fault persists, check it again when the weather turns fine. 5. If the fault is not caused by the foregoing reasons and still exists, please contact Sungrow Service.

Alarm ID	Alarm Name	Corrective Measures
106	Grounding cable fault	<ol style="list-style-type: none"> 1. Check whether the AC cable is correctly connected. 2. Check whether the grounding cable and wire cores are wrongly insulated. 3. If the alarm persists, contact SUNGROW.
088	Arc fault	<ol style="list-style-type: none"> 1. Disconnect the DC inputs and check whether the DC cables are damaged, whether the wiring terminals or fuses, if necessary, are loose or in poor contact, and whether there is a PV module burnt. If so, take corresponding corrective measures. 2. After taking corresponding measures in step 1, reconnect the DC inputs. Remove the arc fault through the App, and therefore the inverter will recover. 3. If the alarm persists, contact SUNGROW.
503, 504, 505, 506, 513	System alarm	<p>The inverter can operate normally.</p> <ol style="list-style-type: none"> 1. Check whether the related cable connection and terminals are abnormal, and check whether the ambient environment is abnormal. If so, take corrective measures. 2. If the alarm persists, contact SUNGROW.
021, 022, 036, 038, 041, 044, 048, 100, 105, 107, 200, 201, 202, 207, 306, 312, 315, 316, 324	System fault	<ol style="list-style-type: none"> 1. Wait for the inverter to recover. 2. Disconnect the AC and DC switches or circuit breakers, and connect them again after 15 minutes. 3. If the alarm persists, contact SUNGROW.

9.2 Maintenance

9.2.1 Maintenance Notices

The DC switch can be secured with a lock in the OFF position or a certain angle beyond the OFF position.

⚠ DANGER

Risk of inverter damage or personal injury due to incorrect service!

- Always keep in mind that the inverter is powered by dual sources: PV strings and utility grid.

Before any service work, observe the following procedure.

- Disconnect the AC circuit breaker and then set the DC load-break switch of the inverter to OFF;
- The DC switch can be secured with a lock in the OFF position or a certain angle beyond the OFF position.
- Wait at least 10 minutes for inner capacitors to discharge completely;
- Verify that there is no voltage or current before pulling any connector.

⚠ CAUTION

Keep non-related persons away!

A temporary warning sign or barrier must be posted to keep non-related persons away while performing electrical connection and service work.

NOTICE

- Restart the inverter only after removing the fault that impairs safety performance.
- As the inverter contains no component parts that can be maintained, never arbitrarily replace any internal components.
- For any maintenance need, please contact SUNGROW. Otherwise, SUNGROW shall not be held liable for any damage caused.



Servicing of the device in accordance with the manual should never be undertaken in the absence of proper tools, test equipments or the latest revision of the manual which has been clearly and thoroughly understood.

9.2.2 Routine Maintenance

Item	Method	Period
System clean	Check the temperature and dust of the inverter. Clean the inverter enclosure if necessary.	Six months to a year (depending on the dust contents in air)
Electrical connection	Check whether all cable are firmly connected in place. Check whether there is damage to the cables, especially the surface in contact with metal.	6 months after commissioning and then once or twice a year.
General status of the system	<ul style="list-style-type: none"> • Visual check for any damage or deformation of the inverter. • Check any abnormal noise during the operation. • Check each operation parameter. • Be sure that nothing covers the heat sink of the inverter. 	Every 6 months

10 Appendix

10.1 Technical Data

Parameter	SG2.0RS-S	SG2.5RS-S	SG3.0RS-S
Input (DC)			
Recommended max. PV input power	3.0 kWp	3.75 kWp	4.5 kWp
Max. PV input voltage	600 V *		
Min. PV input voltage / Start-up input voltage	40 V / 50 V		
Nominal input voltage	360 V		
MPP voltage range	40 V – 560 V		
No. of MPPTs	1		
Default No. of PV strings per MPPT	1		
Max. PV input current	16 A		
Max. DC short-circuit current	20 A		
Output (AC)			
Nominal AC output power	2000 W	2500 W	3000 W
Max. AC output apparent power	2000 VA	2500 VA	3000 VA
Max. AC output current	9.1 A	11.4 A	13.7 A
Nominal AC voltage	220 V / 230 V / 240 V		
AC voltage range	154 V AC – 286 V AC		
Nominal grid frequency / Grid frequency range	50 Hz / 45 Hz – 55 Hz, 60 Hz / 55 Hz – 65 Hz		
Harmonic (THD)	< 3 % (at nominal power)		
Power factor at nominal power / Adjustable power factor	> 0.99 / 0.8 leading - 0.8 lagging		
Feed-in phases / connection phases	1 / 1		
Efficiency			
Max. efficiency / European efficiency	98.0 % / 97.3 %	98.0% / 97.5 %	98.0 % / 97.5 %

Parameter	SG2.0RS-S	SG2.5RS-S	SG3.0RS-S
Protection			
Grid monitoring	Yes		
DC reverse polarity protection	Yes		
AC short circuit protection	Yes		
Leakage current protection	Yes		
Surge Protection	DC type II / AC type II		
DC switch	Yes		
PV string current monitoring	Yes		
PID recovery	Yes		
Arc fault circuit interrupter (AFCI)	Optional		
PID recovery function	Yes		
General Data			
Dimensions (W x H x D)	320 mm x 225 mm x 120 mm		
Weight	6 kg		
Mounting method	Wall-mounting bracket		
Topology	Transformerless		
Degree of protection	IP65		
Operating ambient temperature range	-25°C to +60°C		
Allowable relative humidity range (non-condensing)	0 – 100 %		
Max. operating altitude	4000 m		
Cooling method	Natural cooling		
Display	LED digital display & LED indicator		
Communication	Ethernet / WLAN / RS485 / DI (Ripple control & DRM)		
DC connection type	MC4 (Max. 6 mm ²)		
AC connection type	Plug and play (Max. 6 mm ²)		
Grid support	Active/reactive power control and power ramp rate control		

* The inverter enters standby state when the input voltage ranges between 560 V and 600 V.

Parameter	SG3.0RS	SG3.6RS	SG4.0RS
Input (DC)			
Recommended max. PV input power	4.5 kWp	5.4 kWp	6 kWp
Max. PV input voltage	600 V *		
Min. PV input voltage / Start-up input voltage	40 V / 50 V		
Nominal input voltage	360 V		
MPP voltage range	40 V – 560 V		
No. of MPPTs	2		
Default No. of PV strings per MPPT	1		
Max. PV input current	32 A (16 A / 16 A)		
Max. DC short-circuit current	40 A (20 A / 20 A)		
Output (AC)			
Nominal AC output power	3000 W	3680 W	4000 W
Max. AC output apparent power	3000 VA	3680 VA	4000 VA
Max. AC output current	13.7 A	16 A	18.2 A
Nominal AC voltage	220 V / 230 V / 240 V		
AC voltage range	154 V AC – 286 V AC		
Nominal grid frequency / Grid frequency range	50 Hz / 45 Hz – 55 Hz, 60 Hz / 55 Hz – 65 Hz		
Harmonic (THD)	< 3 % (at nominal power)		
Power factor at nominal power / Adjustable power factor	> 0.99 / 0.8 leading - 0.8 lagging		
Feed-in phases / connection phases	1 / 1		
Efficiency			
Max. efficiency / European efficiency	98.1 % / 97.0 %	98.1 % / 97.1 %	98.1 % / 97.4 %
Protection			
Grid monitoring	Yes		
DC reverse polarity protection	Yes		
AC short circuit protection	Yes		

Parameter	SG3.0RS	SG3.6RS	SG4.0RS
Leakage current protection	Yes		
Surge Protection	DC type II / AC type II		
DC switch	Yes		
PV string current monitoring	Yes		
Arc fault circuit interrupter (AFCI)	Optional		
PID recovery function	Yes		
General Data			
Dimensions (W x H x D)	410 mm x 270 mm x 150 mm		
Weight	10 kg		
Mounting method	Wall-mounting bracket		
Topology	Transformerless		
Degree of protection	IP65		
Operating ambient temperature range	-25°C to +60°C		
Allowable relative humidity range (non-condensing)	0 – 100 %		
Max. operating altitude	4000 m		
Cooling method	Natural cooling		
Display	LED digital display & LED indicator		
Communication	Ethernet / WLAN / RS485 / DI (Ripple control & DRM)		
DC connection type	MC4 (Max. 6 mm ²)		
AC connection type	Plug and play (Max. 6 mm ²)		
Grid support	Active/reactive power control and power ramp rate control		

* The inverter enters standby state when the input voltage ranges between 560 V and 600 V.

Parameter	SG3.0RS	SG3.6RS
Input (DC)		
Recommended max. PV input power	7.5 kWp	9 kWp
Max. PV input voltage	600 V *	
Min. PV input voltage / Start-up input voltage	40 V / 50 V	

Parameter	SG3.0RS	SG3.6RS
Nominal input voltage	360 V	
MPP voltage range	40 V – 560 V	
No. of MPPTs	2	
Default No. of PV strings per MPPT	1	
Max. PV input current	32 A (16 A / 16 A)	
Max. DC short-circuit current	40 A (20 A / 20 A)	
Output (AC)		
Nominal AC output power	4999 W for "AU", 5000 W for others	6000 W
Max. AC output apparent power	4999 VA for "AU", 5000 VA for others	6000 VA
Max. AC output current	21.7 A for "AU", 22.8 A for others	27.3 A
Nominal AC voltage	220 V / 230 V / 240 V	
AC voltage range	154 V AC – 286 V AC	
Nominal grid frequency / Grid frequency range	50 Hz / 45 Hz – 55 Hz, 60 Hz / 55 Hz – 65 Hz	
Harmonic (THD)	< 3 % (at nominal power)	
Power factor at nominal power / Adjustable power factor	> 0.99 / 0.8 leading - 0.8 lagging	
Feed-in phases / connection phases	1 / 1	
Efficiency		
Max. efficiency / European efficiency	98.1 % / 97.5 %	98.1 % / 97.8 %
Protection		
Grid monitoring	Yes	
DC reverse polarity protection	Yes	
AC short circuit protection	Yes	
Leakage current protection	Yes	
Surge Protection	DC type II / AC type II	
DC switch	Yes	
PV string current monitoring	Yes	
Arc fault circuit interrupter (AFCI)	Optional	
PID recovery function	Yes	
General Data		
Dimensions (W x H x D)	410 mm x 270 mm x 150 mm	

Parameter	SG3.0RS	SG3.6RS
Weight	10 kg	
Mounting method	Wall-mounting bracket	
Topology	Transformerless	
Degree of protection	IP65	
Operating ambient temperature range	-25°C to +60°C	
Allowable relative humidity range (non-condensing)	0 – 100 %	
Max. operating altitude	4000 m	
Cooling method	Natural cooling	
Display	LED digital display & LED indicator	
Communication	Ethernet / WLAN / RS485 / DI (Ripple control & DRM)	
DC connection type	MC4 (Max. 6 mm ²)	
AC connection type	Plug and play (Max. 6 mm ²)	
Grid support	Active/reactive power control and power ramp rate control	

* The inverter enters standby state when the input voltage ranges between 560 V and 600 V.

10.2 Quality Assurance

When product faults occur during the warranty period, SUNGROW will provide free service or replace the product with a new one.

Evidence

During the warranty period, the customer shall provide the product purchase invoice and date. In addition, the trademark on the product shall be undamaged and legible. Otherwise, SUNGROW has the right to refuse to honor the quality guarantee.

Conditions

- After replacement, unqualified products shall be processed by SUNGROW.
- The customer shall give SUNGROW a reasonable period to repair the faulty device.

Exclusion of Liability

In the following circumstances, SUNGROW has the right to refuse to honor the quality guarantee:

- The free warranty period for the whole machine/components has expired.
- The device is damaged during transport.
- The device is incorrectly installed, refitted, or used.

- The device operates in harsh conditions beyond those described in this manual.
- The fault or damage is caused by installation, repairs, modification, or disassembly performed by a service provider or personnel not from SUNGROW.
- The fault or damage is caused by the use of non-standard or non-SUNGROW components or software.
- The installation and use range are beyond stipulations of relevant international standards.
- The damage is caused by unexpected natural factors.

For faulty products in any of above cases, if the customer requests maintenance, paid maintenance service may be provided based on the judgment of SUNGROW.

10.3 Contact Information

Should you have any question about this product, please contact us.

We need the following information to provide you the best assistance:

- Model of the device
- Serial number of the device
- Fault code/name
- Brief description of the problem

China (HQ)

Sungrow Power Supply Co., Ltd
Hefei
+86 551 65327834
service@sungrowpower.com

Australia

Sungrow Australia Group Pty. Ltd.
Sydney
+61 2 9922 1522
service@sungrowpower.com.au

Brazil

Sungrow Do Brasil
Sao Paulo
+55 0800 677 6000
latam.service@sungrowamericas.com

France

Sungrow France
Lyon
+33420102107
service@sungrow-emea.com

Germany, Austria, Switzerland

Sungrow Deutschland GmbH
Munich
+49 0800 4327 9289
service@sungrow-emea.com

Greece

Service Partner – Survey Digital
+30 2391052757
service@sungrow-emea.com

<p>India</p> <p>Sungrow (India) Private Limited Gurgaon +91 080 41201350 service@in.sungrowpower.com</p>	<p>Italy</p> <p>Sungrow Italy Verona +39 0800 974739 (Residential) +39 045 4752117 (Others) service@sungrow-emea.com</p>
<p>Japan</p> <p>Sungrow Japan K.K. Tokyo + 81 3 6262 9917 service@jp.sungrowpower.com</p>	<p>Korea</p> <p>Sungrow Power Korea Limited Seoul +82 70 7719 1889 service@kr.sungrowpower.com</p>
<p>Malaysia</p> <p>Sungrow SEA Selangor Darul Ehsan +60 19 897 3360 service@my.sungrowpower.com</p>	<p>Philippines</p> <p>Sungrow Power Supply Co., Ltd Mandaluyong City +63 9173022769 service@ph.sungrowpower.com</p>
<p>Thailand</p> <p>Sungrow Thailand Co., Ltd. Bangkok +66 891246053 service@th.sungrowpower.com</p>	<p>Spain</p> <p>Sungrow Ib é rica S.A.U. Mutilva +34 948 05 22 04 service@sungrow-emea.com</p>
<p>Romania</p> <p>Service Partner - Elerex service@sungrow-emea.com</p>	<p>Turkey</p> <p>Sungrow Deutschland GmbH Turkey Istanbul +90 216 663 61 80 service@sungrow-emea.com</p>
<p>UK</p> <p>Sungrow Power UK Ltd. Milton Keynes +44 (0) 01908 414127 service@sungrow-emea.com</p>	<p>U.S.A, Mexico</p> <p>Sungrow USA Corporation Phoenix +1 833 747 6937 techsupport@sungrow-na.com</p>

Vietnam

Sungrow Vietnam

Hanoi

+84 918 402 140

service@vn.sungrowpower.com**Belgium, Netherlands and Luxembourg (Benelus)**+31 08000227012 (only for
Netherlands)service@sungrow-emea.com

Poland

+48 221530484

-

service@sungrow-emea.com
